

Pioneer

DJ EFFECTOR

EFX-1000

Operating Instructions

IMPORTANT



The lightning flash with arrowhead symbol, within an equilateral triangle, is intended to alert the user to the presence of uninsulated "dangerous voltage" within the product's enclosure that may be of sufficient magnitude to constitute a risk of electric shock to persons.

CAUTION

RISK OF ELECTRIC SHOCK
DO NOT OPEN



CAUTION: TO PREVENT THE RISK OF ELECTRIC SHOCK, DO NOT REMOVE COVER (OR BACK). NO USER-SERVICEABLE PARTS INSIDE. REFER SERVICING TO QUALIFIED SERVICE PERSONNEL.

The exclamation point within an equilateral triangle is intended to alert the user to the presence of important operating and maintenance (servicing) instructions in the literature accompanying the appliance.

D3-4-2-1-1_En-A

WARNING

This equipment is not waterproof. To prevent a fire or shock hazard, do not place any container filled with liquid near this equipment (such as a vase or flower pot) or expose it to dripping, splashing, rain or moisture.

D3-4-2-1-3_A_En

When using this product follow the instructions written on the underside of the unit, which concern rated voltage, etc.

D3-4-2-2-4_En

IMPORTANT NOTICE— THE SERIAL NUMBER FOR THIS EQUIPMENT IS LOCATED IN THE BOTTOM. PLEASE WRITE THIS SERIAL NUMBER ON YOUR ENCLOSED WARRANTY CARD AND KEEP IN A SECURE AREA. THIS IS FOR YOUR SECURITY.

D1-4-2-6-1_En

Information to User

Alteration or modifications carried out without appropriate authorization may invalidate the user's right to operate the equipment.

D8-10-2_En

This Class B digital apparatus complies with Canadian ICES-003.

Cet appareil numérique de la Classe B est conforme à la norme NMB-003 du Canada.

D8-10-1-3_EF

CAUTION — PREVENT ELECTRIC SHOCK DO NOT USE THIS (POLARIZED) PLUG WITH AN EXTENSION CORD. RECEPTACLE OR OTHER OUTLET UNLESS THE BLADES CAN BE FULLY INSERTED TO PREVENT BLADE EXPOSURE.

ATTENTION — POUR PREVENIR LES CHOCS ELECTRIQUES NE PAS UTILISER CETTE FICHE POLARISEE AVEC UN PROLONGATEUR UNE PRISE DE COURANT OU UNE AUTRE SORTIE DE COURANT, SAUF SI LES LAMES PEUVENT ETRE INSEREES A FOND SANS EN LAISSER AUCUNE PARTIE A DECOUVERT.

D2-4-4-1_EF

WARNING: Handling the cord on this product or cords associated with accessories sold with the product will expose you to lead, a chemical known to the State of California and other governmental entities to cause cancer and birth defects or other reproductive harm.

Wash hands after handling

D36-P4_En

NOTE: THE NO USER-SERVICEABLE PARTS COMPARTMENT WARNING IS LOCATED ON THE APPLIANCE BOTTOM.

IMPORTANT SAFETY INSTRUCTIONS

READ INSTRUCTIONS — All the safety and operating instructions should be read before the product is operated.

RETAIN INSTRUCTIONS — The safety and operating instructions should be retained for future reference.

HEED WARNINGS — All warnings on the product and in the operating instructions should be adhered to.

FOLLOW INSTRUCTIONS — All operating and use instructions should be followed.

CLEANING — The product should be cleaned only with a polishing cloth or a soft dry cloth. Never clean with furniture wax, benzene, insecticides or other volatile liquids since they may corrode the cabinet.

ATTACHMENTS — Do not use attachments not recommended by the product manufacturer as they may cause hazards.

WATER AND MOISTURE — Do not use this product near water — for example, near a bathtub, wash bowl, kitchen sink, or laundry tub; in a wet basement; or near a swimming pool; and the like.

ACCESSORIES — Do not place this product on an unstable cart, stand, tripod, bracket, or table. The product may fall, causing serious injury to a child or adult, and serious damage to the product. Use only with a cart, stand, tripod, bracket, or table recommended by the manufacturer, or sold with the product. Any mounting of the product should follow the manufacturer's instructions, and should use a mounting accessory recommended by the manufacturer.

CART — A product and cart combination should be moved with care. Quick stops, excessive force, and uneven surfaces may cause the product and cart combination to overturn.



VENTILATION — Slots and openings in the cabinet are provided for ventilation and to ensure reliable operation of the product and to protect it from overheating, and these openings must not be blocked or covered. The openings should never be blocked by placing the product on a bed, sofa, rug, or other similar surface. This product should not be placed in a built-in installation such as a bookcase or rack unless proper ventilation is provided or the manufacturer's instructions have been adhered to.

POWER SOURCES — This product should be operated only from the type of power source indicated on the marking label. If you are not sure of the type of power supply to your home, consult your product dealer or local power company.

LOCATION — The appliance should be installed in a stable location.

NONUSE PERIODS — The power cord of the appliance should be unplugged from the outlet when left un-used for a long period of time.

GROUNDING OR POLARIZATION

• If this product is equipped with a polarized alternating current line plug (a plug having one blade wider than the other), it will fit into the outlet only one way. This is a safety feature. If you are unable to insert the plug fully into the outlet, try reversing the plug. If the plug should still fail to fit, contact your electrician to replace your obsolete outlet. Do not defeat the safety purpose of the polarized plug.

• If this product is equipped with a three-wire grounding type plug, a plug having a third (grounding) pin, it will only fit into a grounding type power outlet. This is a safety feature. If you are unable to insert the plug into the outlet, contact your electrician to replace your obsolete outlet. Do not defeat the safety purpose of the grounding type plug.

POWER-CORD PROTECTION — Power-supply cords should be routed so that they are not likely to be walked on or pinched by items placed upon or against them, paying particular attention to cords at plugs, convenience receptacles, and the point where they exit from the product.

OUTDOOR ANTENNA GROUNDING — If an outside antenna or cable system is connected to the product, be sure the antenna or cable system is grounded so as to provide some protection against voltage surges and built-up static charges. Article B10 of the National Electrical Code, ANSI/NFPA 70, provides information with regard to proper grounding of the mast and supporting structure, grounding of the lead-in wire to an antenna discharge unit, size of grounding conductors, location of antenna-discharge unit, connection to grounding electrodes, and requirements for the grounding electrode. See Figure A.

LIGHTNING — For added protection for this product during a lightning storm, or when it is left unattended and unused for long periods of time, unplug it from the wall outlet and disconnect the antenna or cable system. This will prevent damage to the product due to lightning and power-line surges.

POWER LINES — An outside antenna system should not be located in the vicinity of overhead power lines or other electric light or power circuits, or where it can fall into such power lines or circuits. When installing an outside antenna system, extreme care should be taken to keep from touching such power lines or circuits as contact with them might be fatal.

OVERLOADING — Do not overload wall outlets, extension cords, or integral convenience receptacles as this can result in a risk of fire or electric shock.

OBJECT AND LIQUID ENTRY — Never push objects of any kind into this product through openings as they may touch dangerous voltage points or short-out parts that could result in a fire or electric shock. Never spill liquid of any kind on the product.

SERVICING — Do not attempt to service this product yourself as opening or removing covers may expose you to dangerous voltage or other hazards. Refer all servicing to qualified service personnel.

DAMAGE REQUIRING SERVICE — Unplug this product from the wall outlet and refer servicing to qualified service personnel under the following conditions:

- When the power-supply cord or plug is damaged.
 - If liquid has been spilled, or objects have fallen into the product.
 - If the product has been exposed to rain or water.
 - If the product does not operate normally by following the operating instructions. Adjust only those controls that are covered by the operating instructions as an improper adjustment of other controls may result in damage and will often require extensive work by a qualified technician to restore the product to its normal operation.
 - If the product has been dropped or damaged in any way.
 - When the product exhibits a distinct change in performance — this indicates a need for service.
- REPLACEMENT PARTS** — When replacement parts are required, be sure the service technician has used replacement parts specified by the manufacturer or have the same characteristics as the original part. Unauthorized substitutions may result in fire, electric shock, or other hazards.

SAFETY CHECK — Upon completion of any service or repairs to this product, ask the service technician to perform safety checks to determine that the product is in proper operating condition.

WALL OR CEILING MOUNTING — The product should not be mounted to a wall or ceiling.

HEAT — The product should be situated away from heat sources such as radiators, heat registers, stoves, or other products (including amplifiers) that produce heat.

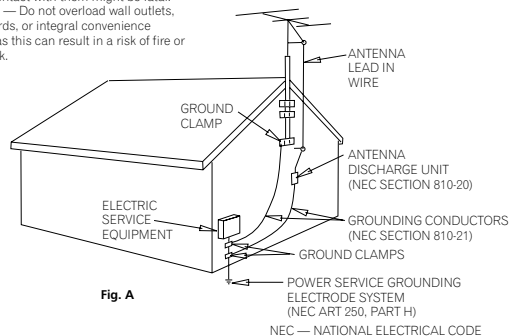

Fig. A

NEC — NATIONAL ELECTRICAL CODE

D1-4-2-2_En

NOTE: This equipment has been tested and found to comply with the limits for a Class B digital device, pursuant to Part 15 of the FCC Rules. These limits are designed to provide reasonable protection against harmful interference in a residential installation. This equipment generates, uses, and can radiate radio frequency energy and, if not installed and used in accordance with the instructions, may cause harmful interference to radio communications. However, there is no guarantee that interference will not occur in a particular installation. If this equipment does cause harmful interference to radio or television reception, which can be determined by turning the equipment off and on, the user is encouraged to try to correct the interference by one or more of the following measures:

- Reorient or relocate the receiving antenna.
- Increase the separation between the equipment and receiver.
- Connect the equipment into an outlet on a circuit different from that to which the receiver is connected.
- Consult the dealer or an experienced radio/TV technician for help.

D8-10-1-2_En

CAUTION: This product satisfies FCC regulations when shielded cables and connectors are used to connect the unit to other equipment. To prevent electromagnetic interference with electric appliances such as radios and televisions, use shielded cables and connectors for connections.

D8-10-3a_En

Thank you for buying this Pioneer product.
Please read through these operating instructions so you will know how to operate your model properly. After you have finished reading the instructions, put them away in a safe place for future reference.

In some countries or regions, the shape of the power plug and power outlet may sometimes differ from that shown in the explanatory drawings. However the method of connecting and operating the unit is the same.

K015 En

FEATURES

① High-Fidelity Sound

The high-fidelity design features a 24-bit A/D and D/A converter (96 kHz sampling) and 32-bit DSP, allowing the addition of effects without lowering the original sound quality; a relay bypass function has also been adopted.

② 3-Band Beat Effector

1) Beat effects [BPM mode]

Equipped with the same automatic BPM counter/beat effector made popular by the EFX-500. Allows effect processing on single selected bands in synch with the track tempo (BPM), for greater expressive possibilities than with conventional all-band effectors.

2) Beat effects [RHYTHM mode]

This industry-first rhythm effector lets you apply effects in synch with the rhythm you input yourself. With the expression of a far wider range of unique effects compared to previous beat effectors, you have the potential for a new level of DJ performance.

③ Digital Jog Break Function

The Jog dial allows real-time control of effect sounds. Up to eight seconds of Jog function can be stored in memory for automated replay. Up to 49 effects can be demonstrated in combination with the beat effector.

④ MIDI IN/OUT Function

External MIDI signals (control signals and timing clock signals) can be used to control the effector, and as a medium for using the effector to control a sequencer or other component.

⑤ Digital Link Function

A variety of functions can be performed by using the dedicated digital link cable to connect this unit to a Pioneer DJ mixer (DJM-1000) with digital link support.

⑥ Digital IN/OUT

Equipped with digital IN/OUT connectors with 24-bit/96 kHz sampling, allowing use in studio track creation and other applications where high sound quality is demanded.

CONTENTS

FEATURES	3
CONFIRM ACCESSORIES	3

QUICK OPERATION GUIDE

USING BEAT EFFECTS [BPM MODE]	4
USING BEAT EFFECTS [RHYTHM MODE]	5
USING THE DIGITAL JOG BREAK	6
USING JOG MEMORY PLAY	6

BEFORE USE

CONNECTIONS	7
Connection Panel	7
Basic Connections	8
EFFECTS	10
Beat Effects	10
Digital Jog Break	12
Effect Parameters	13
CONTROLS AND FUNCTIONS	14
Control Panel	14

OPERATIONS

OPERATIONS	17
Adjusting Input Level	17
Adjusting Effect Output Level	17
Selecting Signal Flow	17
Selecting Foot Switch Operation	17
Selecting the Level Meter Display	17
Digital Link Function	17
Bypass Function	17
Beat Effects [BPM mode]	18
Beat Effects [RHYTHM mode]	19
Digital Jog Break	20
Jog Memory	20

MIDI SETTINGS

MIDI SETTINGS	21
Synchronizing an external sequencer to an audio signal, or using EFX-1000 operation data to operate an external sequencer	21
To synchronize beat effects to external sequencer, or use an external sequencer to operate the EFX-1000	21
MIDI Implementation Chart	22
Control Change (CC) Table	22
Program Change	24
About Rhythm Effects	24
Snapshot	24

OTHER

TROUBLESHOOTING	25
SPECIFICATIONS	27
BLOCK DIAGRAM	27

CONFIRM ACCESSORIES

Operating Instructions	1
Digital link cable	1
Power cord	1
Warranty	1

QUICK OPERATION GUIDE (1/3)

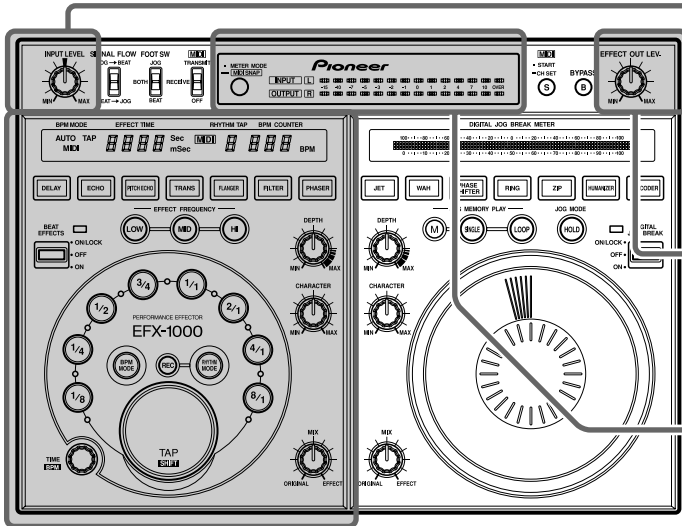

Adjusting the input level

Input signals to the input connectors, and adjust the INPUT LEVEL dial.

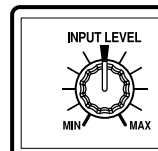

Adjusting effect output level

Rotate the EFFECT OUT LEV. dial to adjust the effect output level.

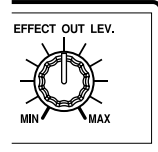

Changing the level meter display mode

Each time the METER MODE button is pressed, the level meter display alternates as follows:

- INPUT, OUTPUT light: Input and output monaural display.
- INPUT, L, R light: Input stereo display.
- OUTPUT, L, R light: Output stereo display.

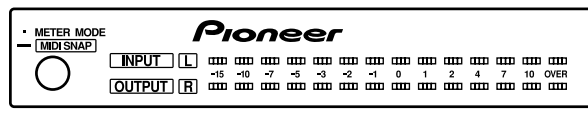

USING BEAT EFFECTS [BPM MODE]

1. Select the BPM measurement mode.

Press the BPM MODE button so that the button lights together with the desired mode indicator (AUTO/MIDI/TAP).

2. Select effect type.

Press the DELAY, ECHO, PITCH ECHO, TRANS, FLANGER, FILTER or PHASER button and the pressed button starts to flash.

3. Select the sound range for the effect.

Press the button of the frequency (LOW, MID, HI) you wish to affect by the beat effect and the corresponding indicator lights.

4. Select the beat with which the effect is to be synchronized.

Press a beat select button (1/8, 1/4, 1/2, 3/4, 1/1, 2/1, 4/1 or 8/1) to light the desired button.

5. Apply an effect.

Press the lever towards you (ON position) to start operation; release it and it returns to the center position (OFF position). In the center position (OFF position), the original sound is not affected. Press the lever away from you to lock it in position so that the beat effect is applied also when the lever is released.

TIME/BPM dial

Set the desired effect time as in step 4. Turn the TIME/BPM dial while holding down the TAP/SHIFT button to make the desired BPM setting. When also the BPM MODE button is held down, BPM can be set in 0.1 increments.

TAP/SHIFT button

BPM can be manually adjusted by adjusting the beat (quarter notes) and hitting this key two times or more.

EFFECT TIME display

BPM measurement mode indicators

DEPTH dial

Sets the parameter 1 of each effect.

RHYTHM TAP display

BPM COUNTER

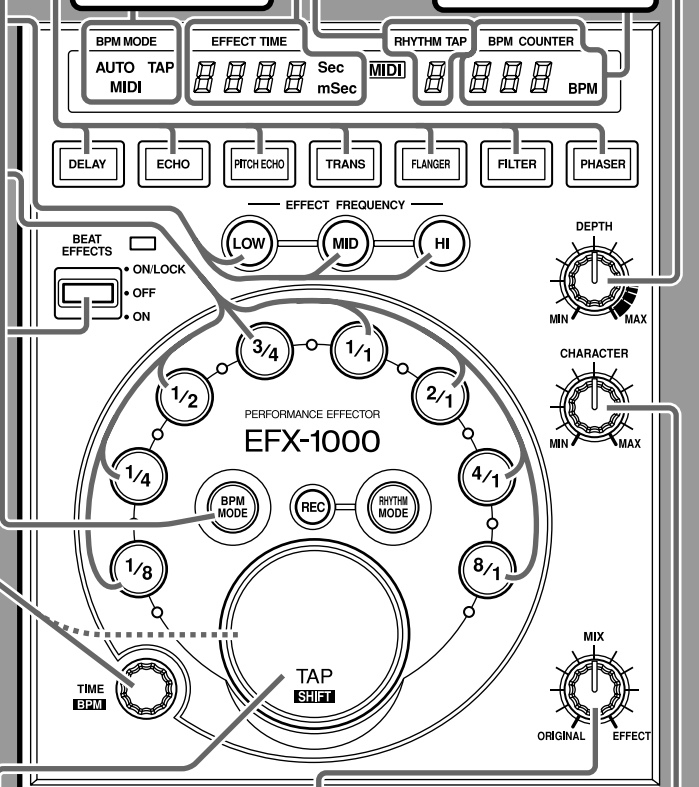

MIX dial

Adjusts the balance between the original sound and effects.

CHARACTER dial

Sets the parameter 2 of each effect.

QUICK OPERATION GUIDE (2/3)

BYPASS button

When the button is pressed (button indicator flashes), the signal entering the input connectors is output directly (without modification) to the output connectors.



SIGNAL FLOW switch

Selects the order in which signals are passed through the electronic sections (from beat effect to digital jog break, or vice versa).

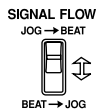

USING BEAT EFFECTS [RHYTHM MODE]

1. Select the rhythm input mode.

Press the RHYTHM MODE button so that the button indicator lights.

2. Select effect type.

Press the DELAY, ECHO, PITCH ECHO, TRANS, FLANGER, FILTER or PHASER button and the pressed button starts to flash.

3. Select the sound range for the effect.

Press the button of the frequency (LOW, MID, HI) you wish to affect by the rhythm effect and the corresponding indicator lights.

4. Set to REC mode.

- When the REC button is pressed, the BPM display indicates "REC".
- If no rhythm has been input, the unit will automatically enter the REC mode in step 1.

5. Input the rhythm.

Tap your finger on the TAP button to input the desired rhythm. As you input the rhythm, the rhythm will be calculated and displayed on the RHYTHM TAP display (up to 8 taps with tap interval of 2 seconds or less).

6. Select the overall rhythm time.

The pressed beat select button will light, and the overall rhythm time will be set at the multiple corresponding to the pressed button.

7. Apply an effect.

Press the lever towards you (ON position) to start operation; release it and it returns to the center position (OFF position). In the center position (OFF position), the original sound is not affected. Press the lever away from you to lock it in position so that the rhythm effect is applied also when the lever is released.

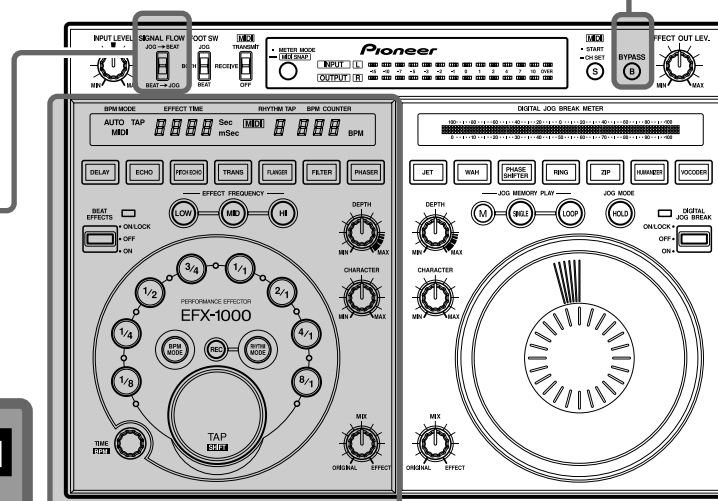

EFFECT TIME display

DEPTH dial

Sets the parameter 1 of each effect.

BPM measurement mode indicators

RHYTHM TAP display

BPM COUNTER

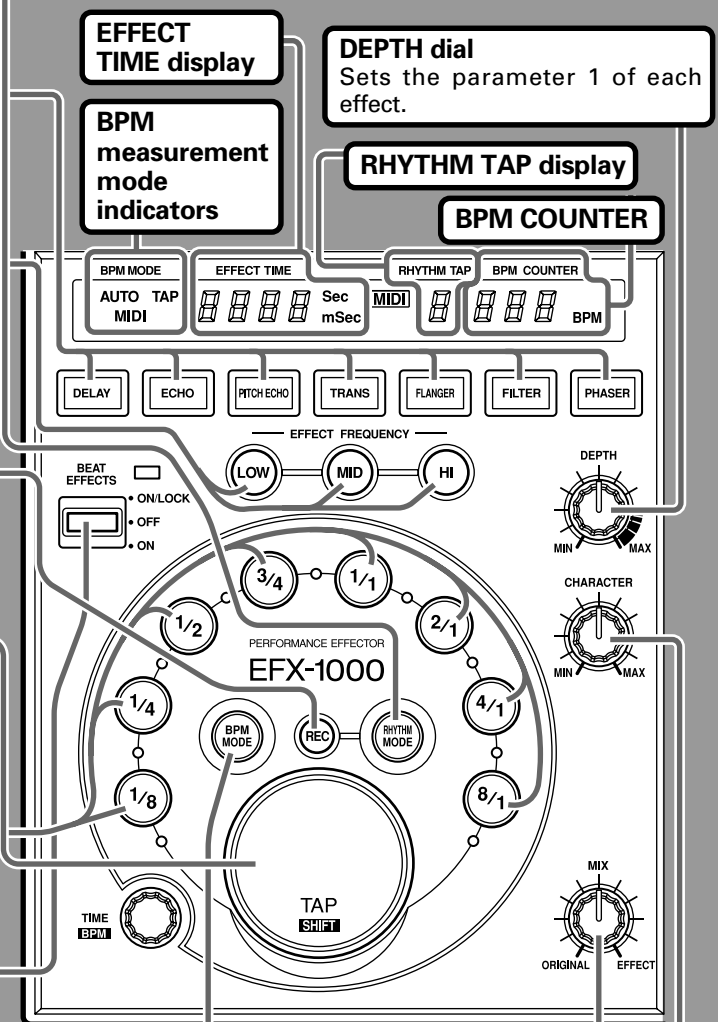

BPM MODE button

When the BPM MODE button is pressed while in the rhythm mode, the mode changes to the beat effect BPM mode.

MIX dial

Adjusts the balance between the original sound and effects.

CHARACTER dial

Sets the parameter 2 of each effect.

QUICK OPERATION GUIDE (3/3)

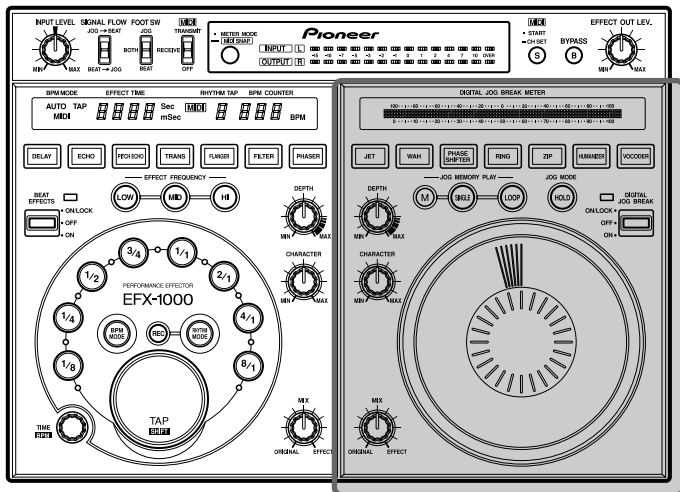

USING THE DIGITAL JOG BREAK

1. Select the desired effect.

Press the desired effect button, JET, WAH, PHASE SHIFTER, RING, ZIP, HUMANIZER or VOCODER to flash the corresponding button.

2. Apply the desired effect.

Turn the Jog dial either while pressing the lever towards you or pressing it away from you (ON position). As the Jog dial is turned, parameters change gradually and the selected effect is applied. When the dial rotation is stopped, the parameter returns to normal.

When the lever is pressed towards you, releasing it causes it to automatically return to the center (OFF position).

DEPTH dial

Sets the parameter 1 of each effect.

DIGITAL JOG BREAK METER

Indicates the amount of control exercised by the Jog dial.

HOLD button

When this button is pressed so that the button indicator lights, effects produced with the Jog dial will continue even when your hand is removed from the dial.

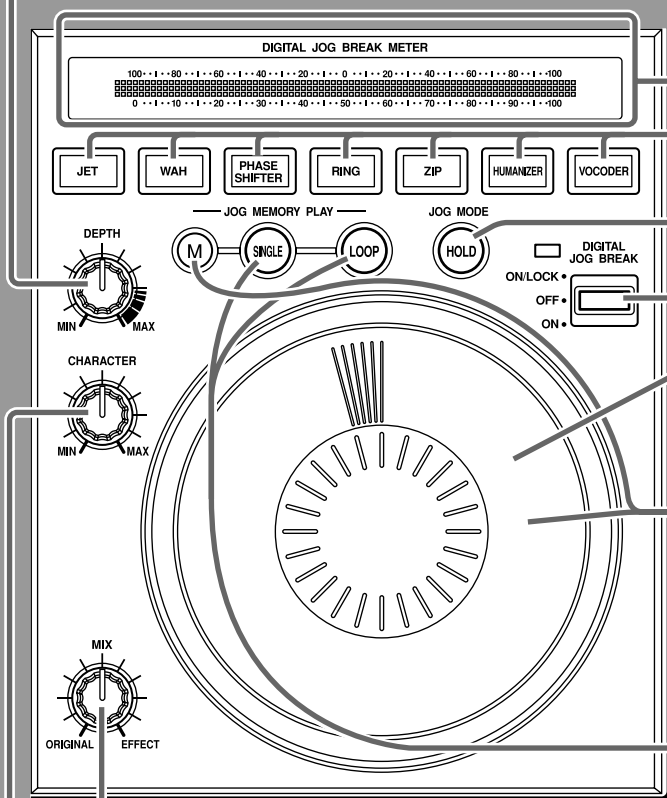

USING JOG MEMORY PLAY

1. Hold the Jog memory button (M) depressed while rotating the Jog dial.

Effect changes produced with the Jog dial will be stored in memory (maximum 8 seconds). When storage is completed, the SINGLE and LOOP buttons light.

2. Press the SINGLE button or LOOP button

- When the SINGLE button is pressed, the stored Jog-dial effect change will be replayed one time only.
- When the LOOP button is pressed, the stored Jog-dial effect change will be replayed repeatedly. Press the button once more to stop the effect.

MIX dial

Adjusts the balance between the original sound and effects.

CHARACTER dial

Sets the parameter 2 of each effect.

CONNECTIONS

Connection Panel

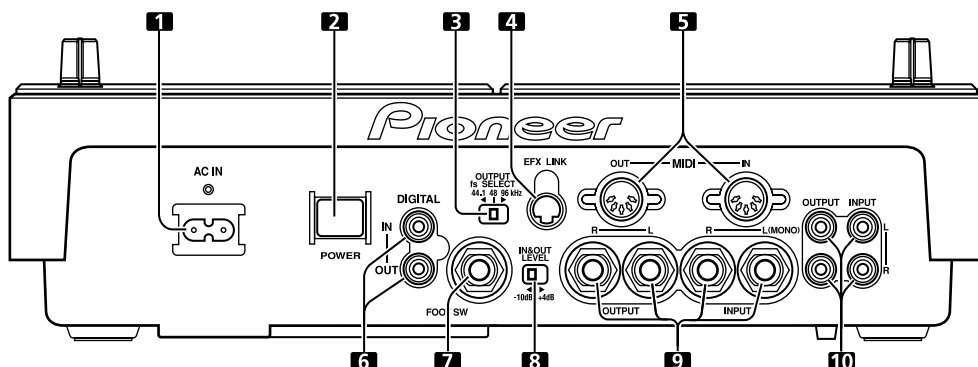

1 Power input socket (AC IN)

Use the provided power cord to connect this socket to an AC outlet.

2 POWER switch

3 Digital OUTPUT fs SELECT switch

Use to change the digital output frequency sampling rate (fs) (44.1kHz/48kHz/96kHz).

4 Link input/output connector (EFX LINK)

When the accessory digital link cable is used to connect this connector to the DJ-mixer DJM-1000 (with digital link support), digital link functions can be used, permitting a variety of new functions.

CAUTION:

The EFX LINK connector is designed to be connected via the provided digital link cable ONLY to a component equipped with the designated digital link function. The unit may be damaged if this connector is mistakenly connected to any other component.

5. MIDI input/output connectors (MIDI OUT, MIDI IN)

Use to connect the effector to a MIDI component (see page 21).

6 Digital input/output connectors (DIGITAL IN, DIGITAL OUT)

Use to connect the effector to a component provided with coaxial digital input/output connectors.

7 Foot switch jack (FOOT SW)

Can be connected to a ON/OFF type foot switch with 6.3mm phone plug to allow ON/OFF control of effects.

Foot switches are available in several types, including press-ON, press-OFF, and latching-type ON/OFF.

8 Input/output gain select switch (IN&OUT LEVEL)

Use to select the input/output gain (-10dB / +4dB).

9 Audio INPUT/OUTPUT jacks

Uses 6.3mm phones plug. For monaural inputs, connect L input channel only for output on both L and R channels. Audio inputs are throughput (output) even when the unit's power is turned OFF.

10 Audio INPUT/OUTPUT jacks

INPUT/OUTPUT connectors using RCA pin jacks.

Audio inputs are throughput (output) even when the unit's power is turned OFF.

■ **Before making or changing the connections, switch off the power switch and disconnect the power cord from the AC outlet. This precaution should also be taken when changing the IN & OUT LEVEL switch and DIGITAL fs SELECT switch.**

- When connections are made to the phone jack inputs and a monaural signal cable is connected to the L (MONO) terminal, inputs can be made to both the L and R channels.
- After all other connections are made, connect the power cord to a household wall outlet or to the auxiliary AC power takeoff on your amplifier.

See page 21 for instructions on how to use the MIDI terminals.

CAUTION:

Do not make any connections that may create signal loops as this will cause circuit oscillations which could damage the speakers.

[Example of connections that must not be performed]

- Do not connect the output of the DJ Mixer to the input terminal of the Effector and the output of the Effector to the input terminal of the same mixer.
- Do not connect the SEND output of the DJ Mixer to the input terminal of the Effector and the output of the Effector to the input terminal of the DJ Mixer (except for the RETURN terminal).

Installation Location

- Avoid mounting on top of amplifiers, near spotlights, or other heat-emitting components and appliances; extended exposure to heat can cause damage to the effector itself.
- Install this unit as far as possible away from tuners and TV sets. A unit installed in close proximity to such equipment may cause noise or degradation of the picture.

Cleaning the unit

To clean the unit wipe with a polishing or a soft, dry cloth. For stubborn dirt, moisten a soft cloth with a weak solution of neutral detergent (diluted in five to six parts water), wring the cloth well, and wipe away the dirt. Use a dry cloth to wipe the surface dry. Do not use volatile liquids such as benzene or thinner which will damage to the unit.

Basic Connections

Before making or changing the connections, switch off the power switch and disconnect the power cord from the AC outlet.

1. Connecting the SEND/RETURN Terminals on the DJ Mixer (on DJ mixer provided with SEND and RETURN terminals)

- Make connections using cables with 1/4-inch/6.3 mm in diameter phone plugs.
- Set the DJ mixer so that the SEND and RETURN terminals can be used.

- If the DJ mixer supports digital link, it can be connected to the EFX LINK connector using the provided digital link cable to eliminate the need for connection by an analog 6.3mm phone plug cable (audio signals transmitted over the digital link cable are in digital format). Also note that extraneous noise may result if both analog and digital link cables are connected simultaneously.

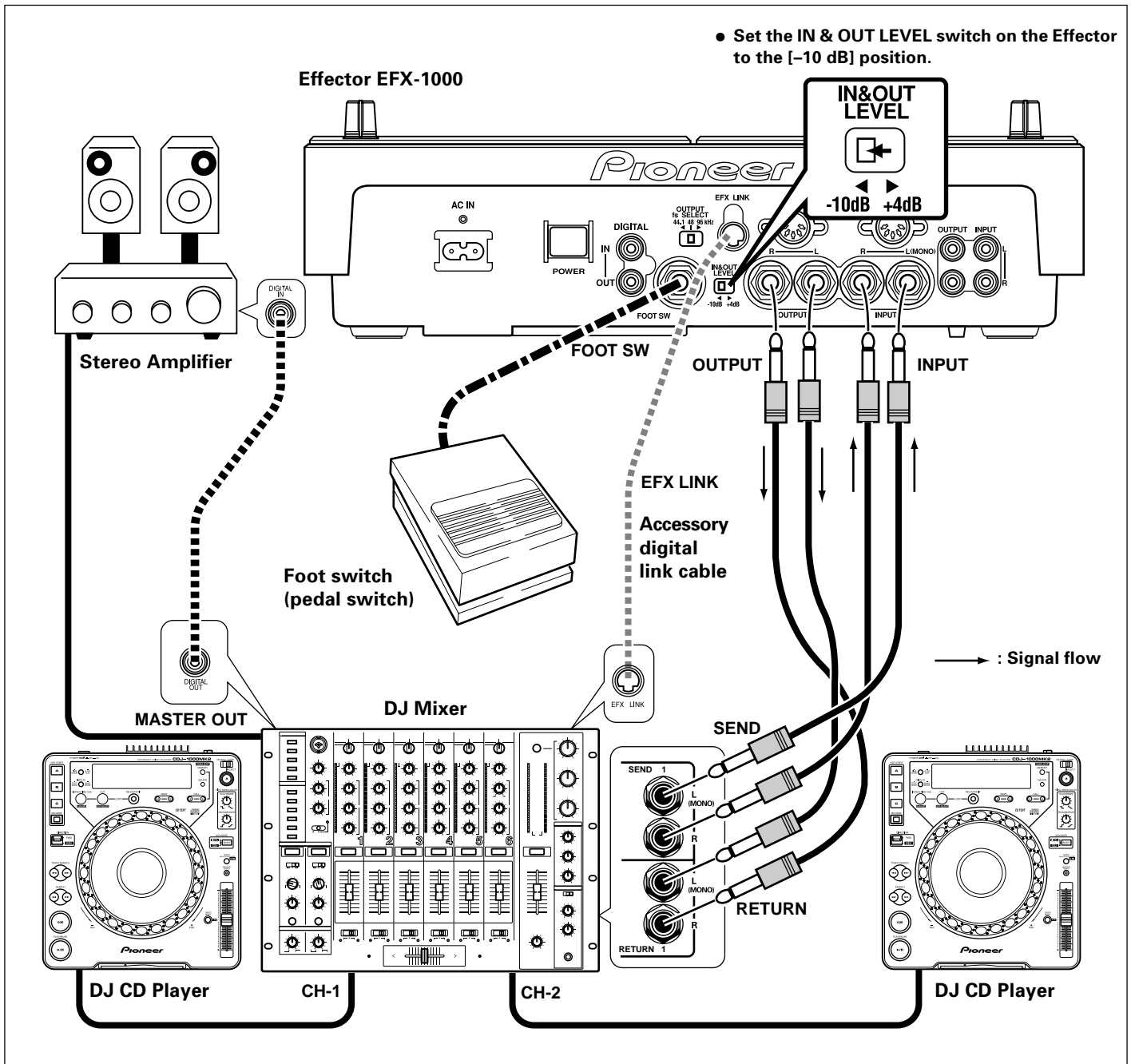

2. Connecting a DJ Mixer and an Audio Amplifier (on DJ mixer not provided with SEND and RETURN terminals)

- Connect using cables with phone plugs (1/4-inch/6.3 mm in diameter) or RCA pin plugs.

- When making connections, do not connect both RCA pin plug cables and phones plug cables for the same connection function (use either one or the other, not both). Also, if you wish to use analog connections, do not also make connections to the digital connectors (digital signals are given priority when connected).
- For digital connections, use RCA pin-plug coaxial cables. Set the OUTPUT fs SELECT switch in accordance with the connected component.

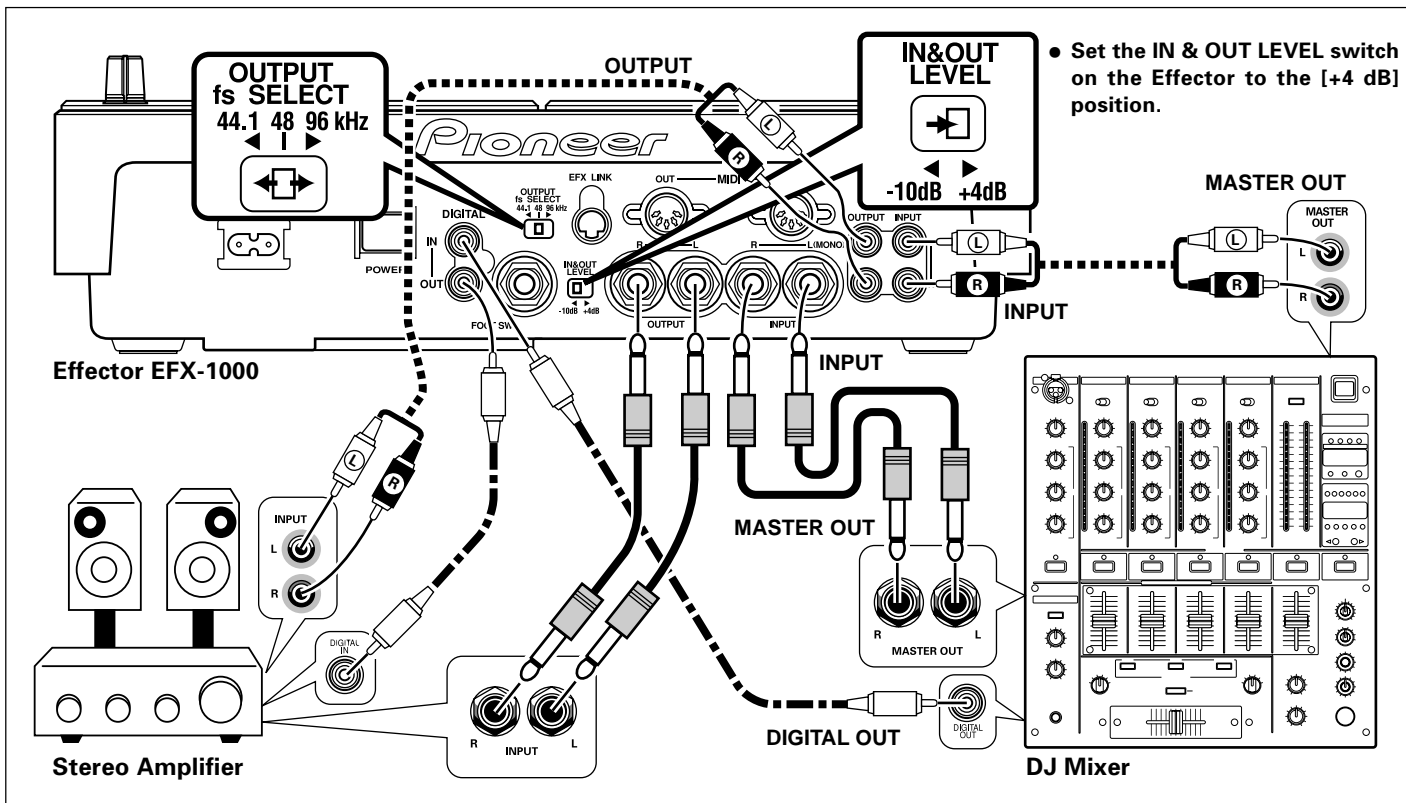

3. Connecting a DJ CD Player and a DJ Mixer (this connection applies effects only to the sound of the DJ CD player on channel 2)

- Connect the units using a cable with RCA pin plugs.
- For digital connections, use RCA pin-plug coaxial cables.

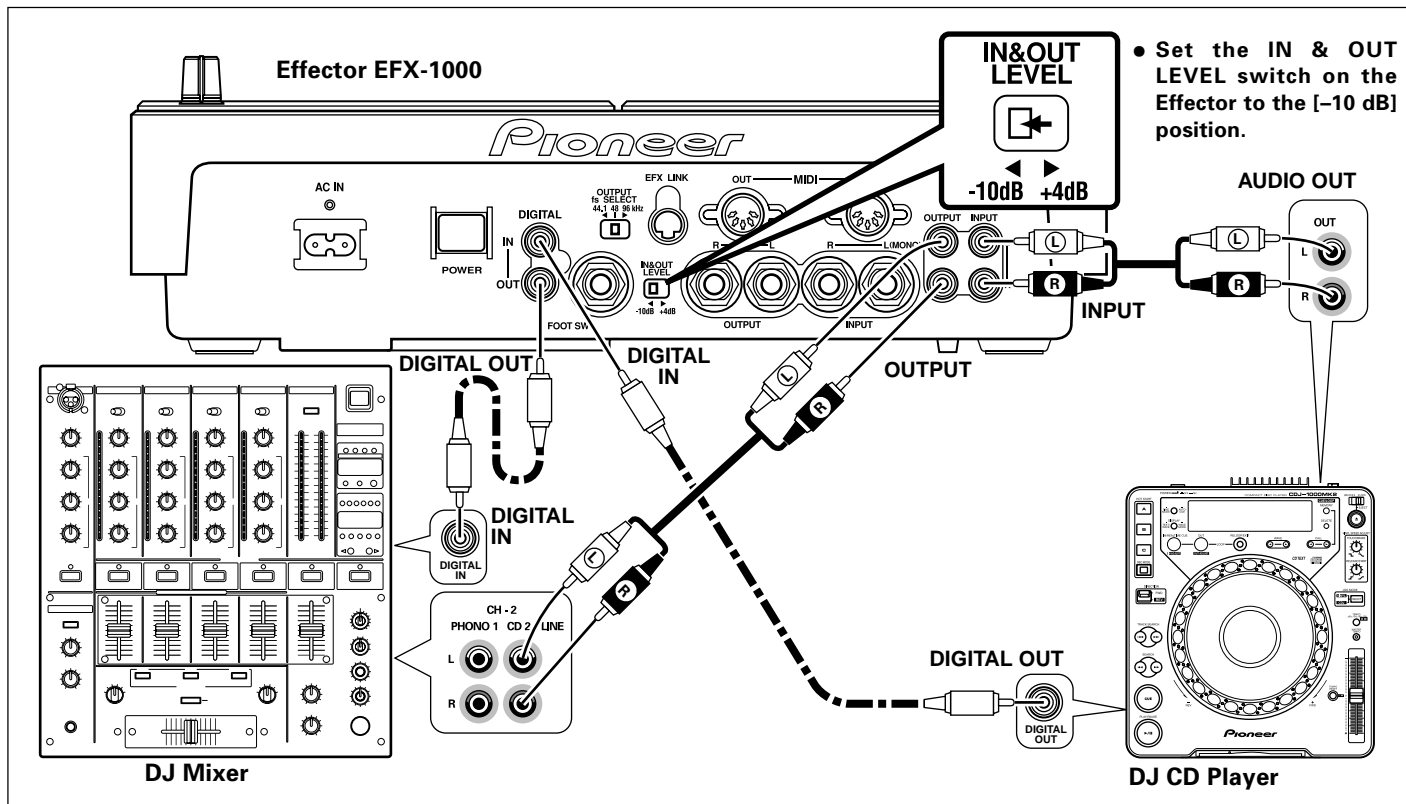

4. Connecting the power cord

- After all other connections are completed, insert the power cord's plug into a wall power outlet or the auxiliary power outlet of an amplifier.

CAUTION:
 Signal inputs are handled in a specific order of priority:
 EFX LINK > digital inputs > analog inputs
 When EFX LINK signals are input, digital signals are not output.

EFFECTS

Beat Effects

1. DELAY effect

Adds delay sound to the original sound.

[BPM mode]

A delay sound is added to the original sound at the value set with the **TIME** dial.

- The **DEPTH** dial can be used to adjust the feedback level. Feedback means to input the delay sound back into the delay input. This control allows the amount of the feedback to be adjusted (near the [MAX] setting, the sound level rises).
- The **CHARACTER** dial can be used to adjust the amount of filter applied to the feedback sound.
- The **MIX** dial can be used to adjust the levels of the original and delay sounds.

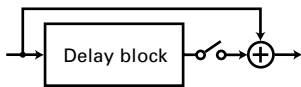
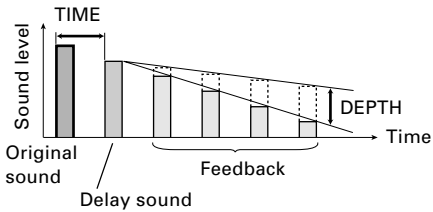

[RHYTHM mode]

A delay sound set with the **TAP** button (TAP delay sound) is added to the original sound (Max 8-TAP).

- The **DEPTH** dial can be used to adjust the TAP delay level (near the [MAX] setting the sound volume will rise).
- The **CHARACTER** dial can be used to adjust the amount of filter applied to the TAP delay sound.
- The **MIX** dial can be used to adjust the levels of the original and TAP delay sounds.

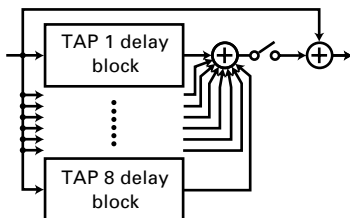
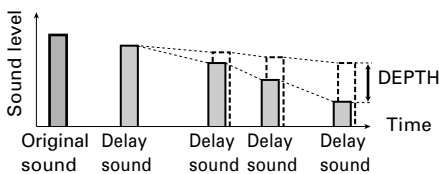

2. ECHO effect

Adds delay sound to the original sound.

[BPM mode]

A delay sound is added to the original sound at the value set with the **TIME** dial.

[RHYTHM mode]

Adds TAP delay sound to the original sound (Max 8-TAP).

Difference from the DELAY effect:

- Even if the **BEAT EFFECTS** lever switch is moved from [ON] to [OFF], the feedback sound or TAP delay sound will continue.
 - In the BPM mode, if the **DEPTH** dial is set to [MAX] and the **BEAT EFFECTS** lever switch is moved from [ON] to [OFF], a hold-delay effect will be produced without attenuating the feedback sound (near the [MAX] setting, the sound level rises).
- In the RHYTHM mode, when the switch is turned [OFF] the effect will end with the final TAP delay sound for the original sound.

BPM mode

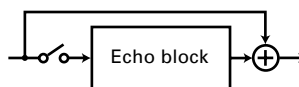

RHYTHM mode

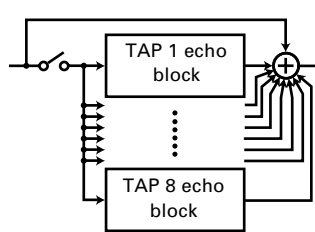

3. PITCH ECHO effect

Changes the pitch of the delay sound, and applies the effect to the original sound.

In the same way as for the **ECHO** effect, the effect sound is maintained even if the **BEAT EFFECTS** lever switch is set from [ON] to [OFF].

[BPM mode]

Changes the pitch of the delay sound set with the **TIME** dial, and applies the effect to the original sound.

- The **DEPTH** dial can be used to adjust the feedback level.
- The **CHARACTER** dial can be used to adjust the pitch of the delay sound.
- The **MIX** dial can be used to adjust the levels of the original and pitch echo sounds.

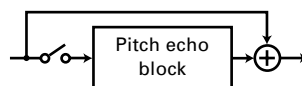

[RHYTHM mode]

Changes the pitch of the TAP delay sound, and applies the effect to the original sound. Although a maximum of 8-TAPS can be recorded, only 4-TAPS can be used for effect.

- The **DEPTH** dial can be used to adjust the TAP delay level (near the [MAX] setting the sound volume will rise somewhat).
- The **CHARACTER** dial can be used to adjust the pitch of the TAP delay sound.
- The **MIX** dial can be used to adjust the levels of the original and pitch echo sounds.

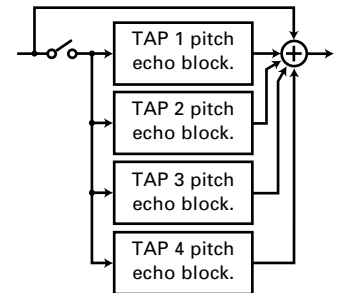

4. TRANS effect

Cuts the original sound intermittently.

[BPM mode]

Cuts the sound at the interval set by the **TIME** dial (cuts latter half of the interval).

- The **DEPTH** dial can be used to adjust the amount that is cut.

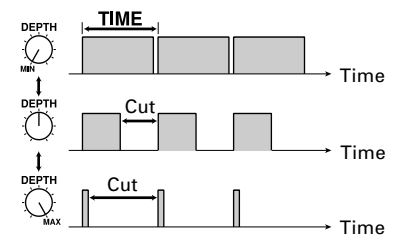

- The **CHARACTER** dial can be used to adjust the phase difference between L and R channels.

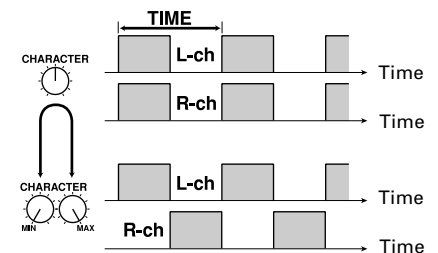

- The **MIX** dial can be used to adjust the levels of the original and trans sounds.

[RHYTHM mode]

Cuts the original sound in synch with the TAP rhythm (Max 8-TAP).

- The **DEPTH** dial can be used to adjust the amount that is cut.
- The **CHARACTER** dial can be used to adjust of phase difference between L and R channels.
- The **MIX** dial can be used to adjust the levels of the original and trans sounds.

5. FLANGER effect

By applying a time-shifted sound to the original, the effect of an ascending or descending jet plane (flange effect) is produced.

[BPM mode]

Changes the frequency range to which the flange effect is applied at the interval set by the **TIME** dial.

- The **DEPTH** dial can be used to adjust the strength of the flange effect by changing the amount of resonance. (When approaching the **[MAX]** setting, the level of the sound increases.)
- The **CHARACTER** dial can be used to adjust the cyclic changes in the flange effect.
- The **MIX** dial can be used to adjust the levels of the original and flanger sounds.

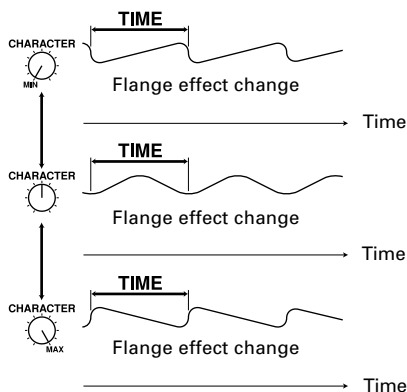
**[RHYTHM mode]**

Changes the frequency subjected to flange effect, in synch with the TAP rhythm (Max 8-TAP).

- The **DEPTH** dial can be used to adjust the strength of the flange effect by changing the amount of resonance. (When approaching the **[MAX]** setting, the level of the sound increases.)
- The **CHARACTER** dial can be used to adjust the cyclic changes in the flange effect.
- The **MIX** dial can be used to adjust the levels of the original and flanger sounds.

6. FILTER effect

A low-pass filter is applied to the original sound to produce more muted sound.

[BPM mode]

The cutoff frequency of the low-pass filter changes with the cycle set by the **TIME** dial.

- The **DEPTH** dial is used to change the unique coloring of the sound by adjusting the amount of resonance. (When approaching the **[MAX]** setting, the level of the sound increases.)

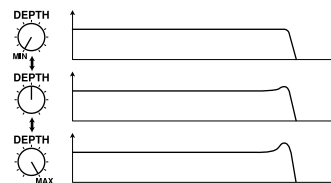

- The **CHARACTER** dial can be used to vary the cutoff frequency of the cyclic low-pass filter.

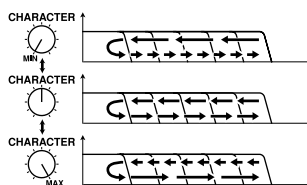

- The **MIX** dial can be used to adjust the levels of the original and filter sounds.

[RHYTHM mode]

Changes cutoff frequency of the low-pass filter, in synch with the TAP rhythm (Max 8-TAP).

- The **DEPTH** dial is used to change the unique coloring of the sound by adjusting the amount of resonance. (When approaching the **[MAX]** setting, the level of the sound increases.)
- The **CHARACTER** dial can be used to vary the cutoff frequency of the cyclic low-pass filter.
- The **MIX** dial can be used to adjust the levels of the original and filter sounds.

7. PHASER effect

Causes a phase effect by applying a phase-shifted sound to the original sound.

[BPM mode]

Changes the frequency range to which the phase effect is applied at the interval set by the **TIME** dial.

- The **DEPTH** dial can be used to adjust the strength of the phase effect by changing the amount of resonance. (When approaching the **[MAX]** setting, the level of the sound increases.)
- The **CHARACTER** dial can be used to adjust the cyclic changes in the phase effect.
- The **MIX** dial can be used to adjust the levels of the original and phaser sounds.

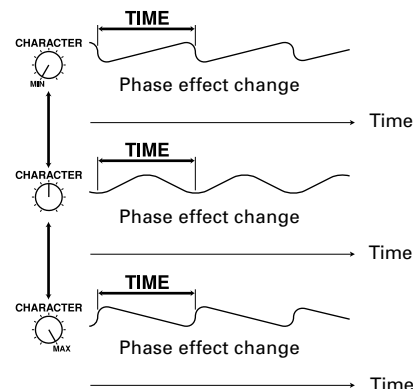
**[RHYTHM mode]**

Changes the frequency subjected to phase effect, in synch with the TAP rhythm (Max 8-TAP).

- The **DEPTH** dial can be used to adjust the strength of the phase effect by changing the amount of resonance. (When approaching the **[MAX]** setting, the level of the sound increases.)
- The **CHARACTER** dial can be used to adjust the cyclic changes in the phase effect.
- The **MIX** dial can be used to adjust the levels of the original and phaser sounds.

Digital Jog Break

1. JET effect

A time-shifted sound is applied to the original, thus producing the effect of a jet airplane ascending or descending (flange effect).

- The Jog dial is used to change the frequency range that is affected by the flange effect.

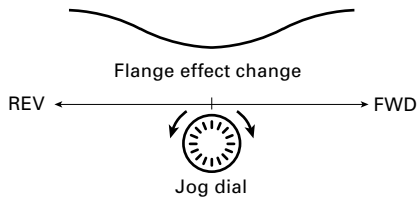

- The amount of resonance is changed using the **DEPTH** dial to emphasize the flange effect. (When approaching the [MAX] setting, the level of the sound increases.)
- The **CHARACTER** dial can be used to adjust the reverb effect.

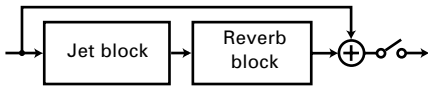

- The **MIX** dial can be used to adjust the levels of the jet + reverb sound and original sound.

2. WAH effect

The filter's cutoff frequency is shifted, causing great change in the sound tone.

- The Jog dial is used to vary the filter's cutoff frequency.

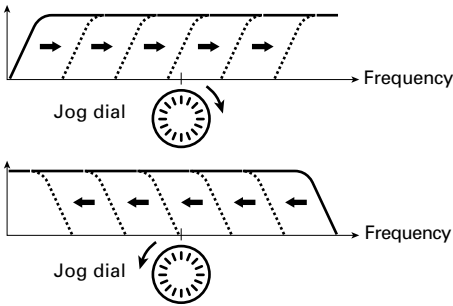

- The **DEPTH** dial is used to change the unique coloring of the sound by adjusting the amount of resonance. (When approaching the [MAX] setting, the level of the sound increases.)

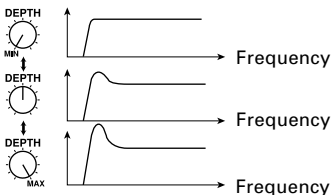

- The **CHARACTER** dial can be used to adjust the reverb effect.

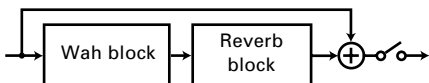

- The **MIX** dial can be used to adjust the levels of the wah + reverb sound and the original sound.

3. PHASE SHIFTER effect

A phase-shifted sound is added to the original, thus producing a phase shifter effect.

- The Jog dial is used to change the frequency range that is affected by the phase effect.

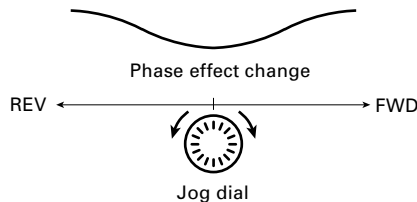

- The amount of resonance is changed using the **DEPTH** dial to emphasize the phase effect. (When approaching the [MAX] setting, the level of the sound increases.)
- The **CHARACTER** dial can be used to adjust the reverb effect.

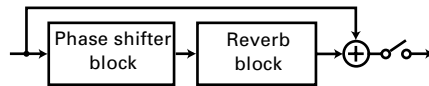

- The **MIX** dial can be used to adjust the levels of the phase shifter + reverb sound and the original sound.

4. RING modulator effect

By modulating the original sound in the shape of a sine wave, the resulting sound coloration resembles a ringing bell.

- The Jog dial is used to vary the sine wave frequency.

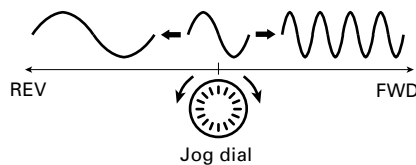

- The **DEPTH** dial can be used to adjust the amplitude of the sine wave.
- The **CHARACTER** dial can be used to adjust the reverb effect.

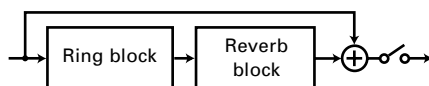

- The **MIX** dial can be used to adjust the levels of the ring + reverb and original sounds.

5. ZIP effect

The Jog dial is used to change the pitch.

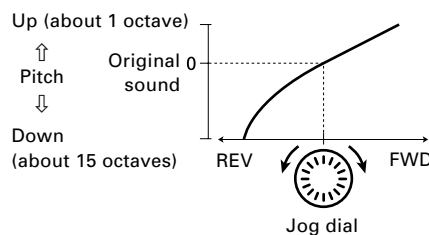

- The **DEPTH** dial can be used to adjust the Jog dial's variable range (step).

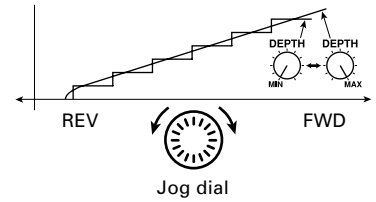

- The **CHARACTER** dial can be used to adjust the reverb effect

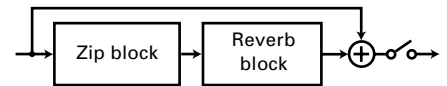

- The **MIX** dial can be used to adjust the levels of the zip+reverb and original sounds.

6. HUMANIZER effect

The original sound is modified to resemble the vowel sounds of the human voice.

- The Jog dial is used to vary the vowel sound coloration.

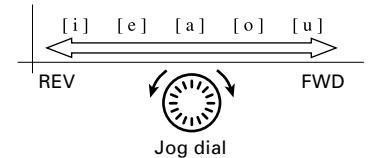

- The **DEPTH** dial is used to change the unique coloring of vowel sounds by adjusting the amount of resonance. (When approaching the [MAX] setting, the level of the sound increases.)

- The **CHARACTER** dial can be used to adjust the reverb effect.

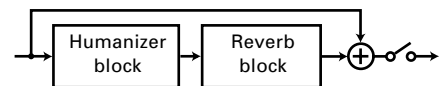

- The **MIX** dial can be used to adjust the levels of the humanizer + reverb and the original sounds.

7. VOCODER effect

The input sound is replaced by an internally generated signal sound, producing a mechanical sound effect.

- The Jog dial is used to change the frequency of the internally generated signal sound.

- The **DEPTH** dial can be used to vary the internally generated sound from the basic sound to a chord. (The sound more nearly approximates the chord as the adjustment approaches the [MAX] setting.)

- The **CHARACTER** dial can be used to change chords codes. Selectable codes include Minor (MIN), Minor7, 7, Major (center position), Major7, Sus4, and Add9 (MAX).

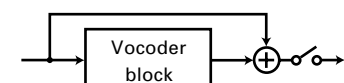

- The **MIX** dial can be used to adjust the levels of the vocoder and original sounds.

Effect Parameters

Beat effect

		Parameter 0 (TIME)	Parameter 1 (DEPTH)	Parameter 2 (CHARACTER)	Parameter 3 (MIX)	Comments
DELAY	BPM MODE	1~16000 [ms]	Feedback (feedback level)	Feedback filter (Amount of feedback filter)	MIX	—
	RHYTHM MODE	1~16000 [ms]*	TAP gain (TAP delay level)	TAP filter (Amount of TAP delay filter)	MIX	Max 8-TAP
ECHO	BPM MODE	1~16000 [ms]	Feedback (feedback level)	Feedback filter (Amount of feedback filter)	MIX	—
	RHYTHM MODE	1~16000 [ms]*	TAP gain (TAP delay level)	TAP filter (Amount of TAP delay filter)	MIX	Max 8-TAP
PITCH ECHO	BPM MODE	1~16000 [ms]	Feedback (feedback level)	Pitch (delay sound pitch)	MIX	—
	RHYTHM MODE	1~16000 [ms]*	TAP gain (TAP delay level)	TAP Pitch (TAP delay sound pitch)	MIX	Max 4-TAP
TRANS	BPM MODE	10~16000 [ms]	Sound cutoff (amount removed)	Phase (L/R-ch phase difference)	MIX	—
	RHYTHM MODE	10~16000 [ms]*	Sound cutoff (amount removed)	Phase (L/R-ch phase difference)	MIX	Max 8-TAP
FLANGER	BPM MODE	10~32000 [ms]	Resonance	LFO pattern (change cyclic effect)	MIX	—
	RHYTHM MODE	10~32000 [ms]*	Resonance	LFO pattern (change cyclic effect)	MIX	Max 8-TAP
FILTER	BPM MODE	10~32000 [ms]	Resonance	LFO pattern (change cyclic effect)	MIX	—
	RHYTHM MODE	10~32000 [ms]*	Resonance	LFO pattern (change cyclic effect)	MIX	Max 8-TAP
PHASER	BPM MODE	10~32000 [ms]	Resonance	LFO pattern (change cyclic effect)	MIX	—
	RHYTHM MODE	10~32000 [ms]*	Resonance	LFO pattern (change cyclic effect)	MIX	Max 8-TAP

* The effect time display in the rhythm mode shows the total time from the beginning to end of TAP input. For this reason, the noted MIN time may be somewhat different from the effect time display.

Digital Jog Break

	Parameter 0 (JOG)	Parameter 1 (DEPTH)	Parameter 2 (CHARACTER)	Parameter 3 (MIX)	Comments
JET	Delay time (amount of delay)	Resonance	Reverb (reverberation effect)	MIX	—
WAH	Frequency (filter frequency)	Resonance	Reverb (reverberation effect)	MIX	—
PHASE SHIFTER	Frequency (filter coefficient)	Resonance	Reverb (reverberation effect)	MIX	—
RING	Frequency (sine wave frequency)	Amplitude (sine-wave amplitude)	Reverb (reverberation effect)	MIX	—
ZIP	Pitch (Scale)	Step (Scale↔Linear)	Reverb (reverberation effect)	MIX	—
HUMANIZER	Vowel (vowel sound)	Resonance	Reverb (reverberation effect)	MIX	—
VOCODER	Oscillator frequency (internally generated sound frequency)	Chord MIX (chord MIX ratio)	Chord	MIX	—

CONTROLS AND FUNCTIONS

Control Panel

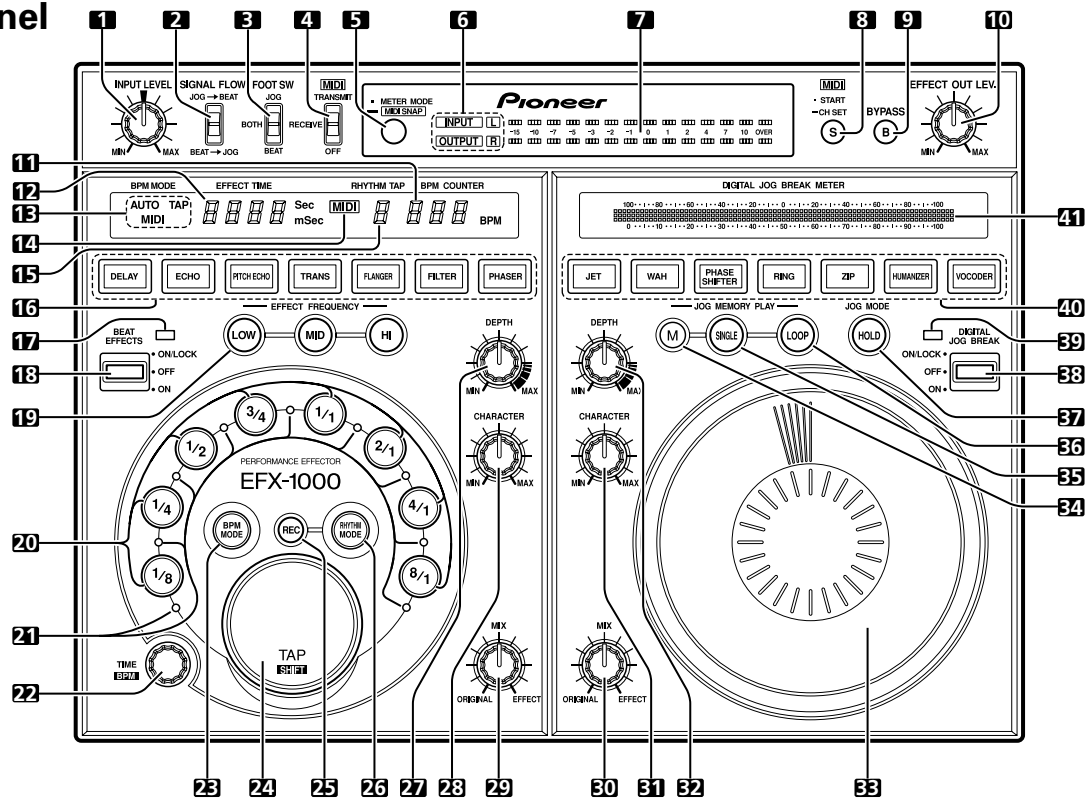

1 INPUT LEVEL dial

Use to adjust the input level. Adjustment range is $-\infty$ to $+9$ dB with analog inputs, and $-\infty$ to 0dB with digital inputs.

2 SIGNAL FLOW switch

Use to select the order of signal flow between beat effect and digital jog break sections.

JOG → BEAT:

Signals travel through the digital jog break section before passing to the beat effect section.

BEAT → JOG:

Signals travel through the beat effect section before passing to the digital jog break section.

3 Foot switch mode selector (FOOT SW)

Use to select which function is controlled (ON/OFF) by an attached foot switch (pedal switch).

BEAT:

Attached foot switch controls beat effect function (ON/OFF).

JOG:

Attached foot switch controls digital jog break function (ON/OFF).

BOTH:

Attached foot switch controls both beat effect function and digital jog break function (ON/OFF).

4 MIDI mode select switch

Select MIDI communication between computer and other instruments, etc.

TRANSMIT:

Acts as MIDI controller

RECEIVE:

Effector can be controlled by MIDI signals.

OFF:

Acts as effector (communication OFF)

5 METER MODE/MIDI SNAP button

[Use to switch the function of the level meter display.]

Each time the button is pressed, the level meter display switches between input and output monaural display, input stereo display, and output stereo display.

[MIDI Snapshot Mode]

When this button is held depressed with the MIDI mode set to [TRANSMIT], a snapshot will be sent to the external MIDI component.

6 Level meter mode display (INPUT, OUTPUT, L, R)

Input and output monaural display:

Both [INPUT] and [OUTPUT] indicators light.

Input stereo display:

[INPUT] and [L], [R] indicators light.

Output stereo display:

[OUTPUT] and [L], [R] indicators light.

7 Level meter display

8 MIDI START/CH SET button / indicator

[MIDI START]

If this button is pressed when MIDI mode is set to [TRANSMIT], the MIDI start/stop signal is output. Lights steadily with START, and goes out with STOP.

[MIDI channel setting (CH SET)]

If this button is held depressed when MIDI mode is set to [TRANSMIT] or [RECEIVE], the MIDI indicator flashes and the MIDI setting mode is enabled.

9 BYPASS button / indicator

When this button is set to ON, the audio input connector signals are fed directly to the output connectors, bypassing the effector circuits.

When the audio input/output connectors are connected directly in this way, the indicator flashes.

10 EFFECT OUT LEV. dial

When effects are set to ON, this dial can be used to control the effect output level. Adjustment range is $-\infty$ to +6dB.

Beat Effect section**11 BPM COUNTER display**

Displays the beats-per-minute of the input source, or the TAP input. The indicator flashes during automatic BPM calculation. When power is first turned on, the counter will flash [120 BPM].

12 EFFECT TIME display

Displays actual effect time.

When power is first turned on, defaults to [500 mSec].

13 BPM measurement mode display (AUTO, MIDI, TAP).

Displays the BPM measurement mode.

14 MIDI display

Lights when handling MIDI data.

15 RHYTHM TAP display

Displays the tap count input in the rhythm mode.

16 Beat effect select button / indicator (DELAY, ECHO, PITCH ECHO, TRANS, FLANGER, FILTER, PHASER).

Use to select the beat effect. All buttons light, and selected effect button flashes.

When power is turned ON, DELAY flashes.

17 BEAT EFFECTS indicator

Lights when beat effects are ON.

18 BEAT EFFECTS lever switch (OFF/ON/ON-LOCK)

Pull the lever toward you [ON] to output beat-effected sounds.

In the middle position beat effects are [OFF]; push the lever away from you to lock the lever in the [ON/LOCK] position (effects are locked ON). When pulled to the [ON] position, beat effects are output only while the lever is held; when your finger is released, the lever returns to middle [OFF] position.

19 EFFECT FREQUENCY select buttons (LOW/MID/HI)

Use to select the frequency band of the sounds to which beat effects will be applied. The button of the selected band will light.

When power is first turned ON, all three of the ranges **LOW**, **MID**, and **HI** are selected. If all three range buttons are OFF, no beat effects will be applied to sounds.

20 Beat select buttons / indicators

(1/8, 1/4, 1/2, 3/4, 1/1, 2/1, 4/1, 8/1)

[During BPM mode]

When a BPM is measured automatically or input manually, the beat select button [1/1] is selected by default. The effect is synchronized automatically to the BPM, and the corresponding effect time is displayed.

If a beat select button is then pressed, the effect is newly synchronized to the corresponding multiple of the BPM (1/8, 1/4, 1/2, 3/4, etc.), thus allowing one-touch change of the BPM synchronization multiple. In turn, the selected beat select button lights, thus showing to what multiple of the actual BPM the effect is synchronized, as well as the multiple of the time parameter.

[During RHYTHM mode]

When the rhythm input with the TAP button is established, [1/1] is selected and a multiple of the rhythm can be selected with the beat select buttons.

21 Beat effect beat-interval indicators

The indicators light to show the period of the effect time.

22 Beat effect TIME/BPM dial

When rotated the effect time selected with the beat select buttons can be changed as desired.

If the dial is rotated while depressing the **TAP** button, the BPM can be set as desired (BPM manual input).

23 BPM MODE button / indicator

Use to turn BPM mode ON, and to select tempo measurement mode (AUTO/MIDI/TAP). During BPM mode, the button lights.

If the **TAP** button is pressed (tapped) during BPM mode, the mode switches to manual BPM measurement mode.

When power is first turned, the mode defaults to AUTO measurement mode.

24 TAP/SHIFT button / indicator**[During BPM mode]**

When this button is tapped, the BPM manual measurement mode is selected, and the interval between two taps (maximum interval 2 seconds) is measured; the corresponding **EFFECT TIME** and **BPM** count is displayed, and the beat select button [1/1] is selected.

If the **TIME/BPM** dial is rotated while pressing this button, the BPM can be adjusted to an optional value (BPM manual input).

[During RHYTHM mode]

When this button is tapped, the rhythm is input (maximum tap interval 2 seconds, up to maximum rhythm count 8). The beat select button [1/1] is selected.

[Tap indicator]

Lights during normal use; goes out only when TAP is pressed.

25 Rhythm REC button

Clears the currently input rhythm and allows input of a new rhythm.

26 RHYTHM MODE button / indicator

When this button is pressed, the **RHYTHM** mode is selected, and the button lights.

27 Beat effect DEPTH dial

Allows adjustment of effect feedback and timing parameters in accordance with the amount of rotation (see page 13).

28 Beat effect CHARACTER dial

Allows adjustment of parameters other than those set with the beat effect **DEPTH** dial (see page 13).

29 Beat effect MIX dial

Rotate to adjust the mixing balance of original and effect sounds. When rotated fully to the [**ORIGINAL**] side, the original (un-effected) sound will be output; as the dial is rotated toward the [**EFFECT**] side, the effect sound is amplified and the original sound decreases.

Digital Jog Break section

30 Digital jog break effect MIX dial

Rotate to adjust the mixing balance of original and effect sounds. When rotated fully to the [**ORIGINAL**] side, the original (un-effected) sound will be output; as the dial is rotated toward the [**EFFECT**] side, the effect sound is amplified and the original sound decreases.

31 Digital jog break effect CHARACTER dial

Allows adjustment of parameters other than those set with the digital jog break **DEPTH** dial (see page 13).

32 Digital jog break DEPTH dial

Allows adjustment of effect feedback and timing parameters in accordance with the amount of rotation (see page 13).

33 Jog dial

Effect parameters change in response to the rotation of the dial.

34 Jog memory button (M)

If the Jog dial is rotated while holding this button depressed, the parameter change in response to the movement is recorded to memory, to a maximum 8 seconds. Recording to memory is not possible during jog memory play.

35 Jog memory SINGLE play button / indicator

If the button is pressed while the button indicator is lighted, the parameter change previously recorded in memory in response to the Jog dial movement is reproduced (played back) one time only.

Indicator lights when the jog operation is stored in memory. Indicator flashes during jog memory single play (playback).

36 Jog memory LOOP play button / indicator

If the button is pressed while the button indicator is lighted, the parameter change previously recorded in memory in response to the Jog dial movement is reproduced (played back repeatedly).

Press again to end Jog memory loop play.

Indicator lights when the jog operation is stored in memory. Indicator flashes during jog memory loop play (playback).

37 Jog HOLD button / indicator

When this button is pressed so that its indicator lights, the effect produced when rotating the Jog dial is maintained even if you remove your hand from the dial (when the hold function is OFF, the effect returns to normal if your hand is removed from the dial). When power is first turned on, the button defaults to jog hold OFF (indicator is off).

38 DIGITAL JOG BREAK effect lever switch (OFF/ON/ON-LOCK)

Pull the lever toward you [**ON**] to output effected sounds. In the middle position effects are [**OFF**]; push the lever away from you to lock the lever in the [**ON/LOCK**] position (effects are locked ON). When pulled to the [**ON**] position, effects are output only while the lever is held; when your finger is released, the lever returns to middle [**OFF**] position.

39 DIGITAL JOG BREAK effect indicator

Lights when digital jog break effect is ON.

40 Digital jog break effect selector buttons / indicators (JET, WAH, PHASE SHIFTER, RING, ZIP, HUMANIZER, VOCODER)

Press to select a desired digital jog break effect. All the buttons light, and the select effect button flashes. When power is turned ON, JET flashes.

41 DIGITAL JOG BREAK METER

During operation of the Jog dial, and during jog memory play, this meter lights to display the corresponding movement.

OPERATIONS

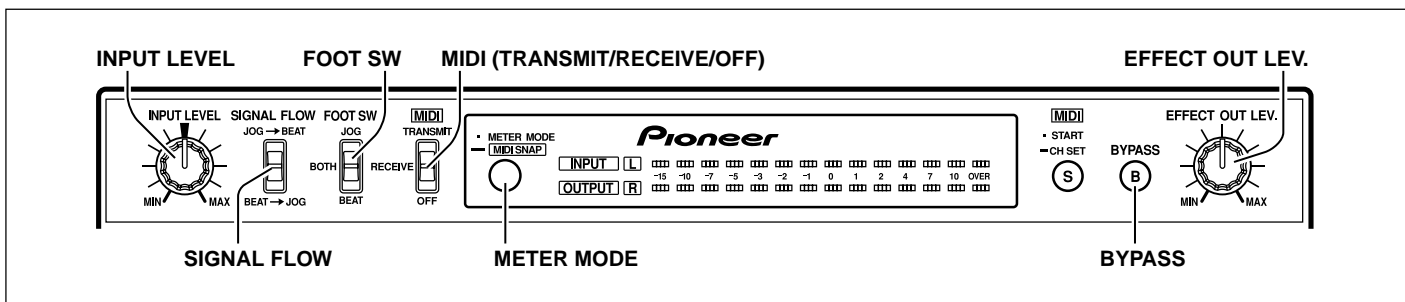

Adjusting Input Level

Adjust the input level so that the sound is not distorted due to an excessive input level.

■ Input signals to the input connectors, and rotate the INPUT LEVEL dial to adjust the level.

- Use the **METER MODE** button to select “input stereo display” (INPUT, L, R indicators light).
- If the proper adjustment cannot be obtained without rotating the **INPUT LEVEL** dial to its extreme [MIN] or [MAX] positions, try changing the position of the rear-panel **IN&OUT LEVEL** switch (-10dB / +4dB).

Adjusting Effect Output Level

Adjusts the sound level of the effect applied to the input sound signal by the beat effect and the digital jog break.

■ Input signals to the input connectors, and rotate the EFFECT OUT LEV. dial to adjust the effect output level.

- Use the **METER MODE** button to select “output stereo display” (OUTPUT, L, R indicators light).
- When both the **BEAT EFFECTS** lever switch and the **DIGITAL JOG BREAK** lever switch are set to [OFF], the output level is not changed by turning the **EFFECT OUT LEV.** dial.

Selecting Signal Flow

Select the order in which signal processing occurs (beat effect or digital jog break)

■ Use the SIGNAL FLOW switch to select the signal processing order:

- When set to the [JOG->BEAT] position, signals are processed for digital jog break effects first, followed by beat effects.
- When set to the [BEAT->JOG] position, signals are processed for beat effects first, followed by digital jog break effects.

Selecting Foot Switch Operation

This effector allows connection of an optional foot switch (pedal switch) for ON/OFF control of beat effects and digital jog break effects. Use the foot switch to select the way in which the foot switch operates.

■ Set the FOOT SW switch to the desired operating position:

- When set to the [JOG] position, the foot switch operates to turn digital jog break effects ON/OFF.
- When set to the [BOTH] position, the foot switch operates to turn both digital jog break effects and beat effects ON/OFF.

- When set to the [BEAT] position the foot switch operates to turn beat effects ON/OFF.
- * Use a commercially available switching-type foot switch with 6.3 mm monaural phone plug.

Selecting the Level Meter Display

This unit's level meter can be set to display the desired mode.

■ Press the METER MODE button to select the desired mode.

- Each time the **METER MODE** button is pressed, the display switches alternately as follows:
 - [INPUT] and [OUTPUT] light:
 - Input and output level are displayed in monaural.
 - [INPUT] and [L], [R] light:
 - Input level is displayed in stereo.
 - [OUTPUT] and [L], [R] light:
 - Output level is displayed in stereo.

Digital Link Function

Fader Effect Function

When the accessory digital link cable is used to connect this unit to a DJ mixer (DJM-1000) with digital link support, send/return connections are completed by a single digital connection, thus enabling fader effect functions that allow the DJ mixer's fader to be used to perform digital jog break.

Bypass Function

This function allows signals to be output directly, without passing through the effects processing circuitry.

■ Press the BYPASS button to make a direct link between input and output.

- When the **BYPASS** button is pressed, the button flashes and input signals are output directly, without passing through the effector circuitry.
- When the **BYPASS** button is flashed, the unit's controls will have no effect on the input signals.

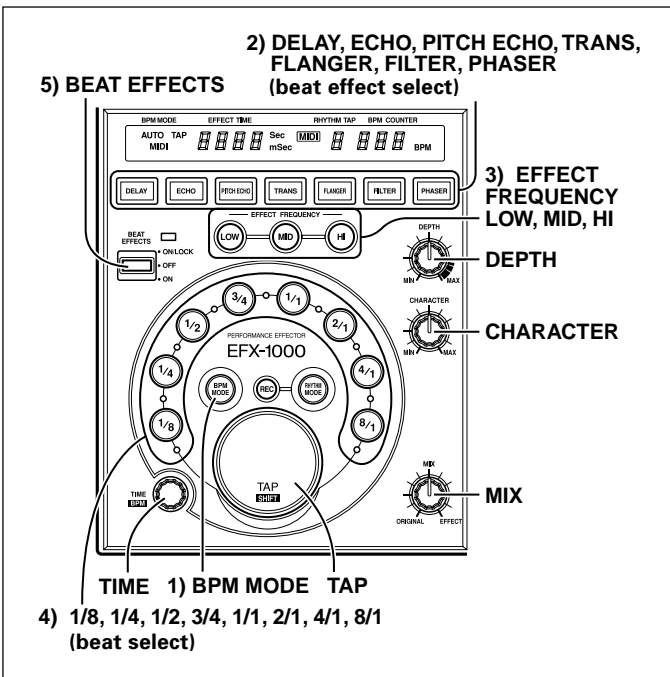

Beat Effects [BPM mode]

Since the beat effect time of the beat effect [BPM mode] can be synchronized in real-time with the BPM (beats per minute), you can easily generate effects in time with the rhythm of a live performance.

1. Press the BPM MODE button to select the BPM (beats-per-minute) measurement mode.

AUTO: BPM is measured automatically from the input music source.

MIDI: BPM is measured automatically based on the MIDI timing clock.

TAP: BPM is input manually by tapping on the TAP button.

- When power is first turned ON, the mode defaults to **AUTO**.
- The selected mode is shown by the BPM mode indicator.
- In the event the input signal cannot be counted properly, the BPM COUNTER flashes.
- The measurement range in the AUTO mode is 70-180 BPM. Correct measurement may not be possible depending on the music track; in this event, input the tempo manually using the TAP mode.

[Manual BPM input using the TAP button]

When the TAP button is tapped two or more times in time with the beat (quarter notes), the average value of the intervals is used to set BPM.

- When BPM is set to **AUTO** or **MIDI** mode, pressing the TAP button changes the BPM measuring mode to the TAP mode, and the unit measures the intervals at which the TAP button is struck.
- When BPM is set with the TAP button, the beat select button [1/1] is selected and the time of 1 beat (quarter notes) is set to the effect time.

[Manual BPM input using the TIME dial]

BPM can be directly set by turning the TIME dial when the TAP button is held down.

- BPM can be set in 0.1 increments by pressing the BPM MODE button and turning the TIME dial while holding down the TAP button. Only decimal values are shown at this time.

2. Use the beat effect select buttons to select the desired effect.

- Select from **DELAY, ECHO, PITCH ECHO, TRANS, FLANGER, FILTER, or PHASER**.
- The selected effect button flashes.
- See pages 10, 11 regarding each effect.

3. Use the EFFECT FREQUENCY buttons (LOW, MID, HI) to select the band to which the effect is to be applied.

- When a button is pressed, the button's indicator will light.
- Each time a button is pressed, it alternates ON/OFF.

4. Press one beat select button to select the beat with which the effect is to be synchronized.

- Select from **1/8, 1/4, 1/2, 3/4, 1/1, 2/1, 4/1, or 8/1**.
- The selected beat button lights.
- When a beat select button is pressed, the corresponding effect time is automatically set.
Example: when BPM is 120,
1/1 = 500 ms
3/4 = 375 ms
1/2 = 250 ms
- When the beat select button is pressed and the TAP button is held down, BPM is automatically set from the effect time.

Manual Input of Effect Time Using the TIME Dial

Normally, the effect time is automatically set when a beat select button is pressed. However, the effect time can be set as desired using the TIME dial.

- When the effect time is changed, the beat select button lights for the beat automatically set in correspondence to the new effect time.

5. Pull the BEAT EFFECTS lever switch to ON to apply the effect.

When pushed away from you to the [ON/LOCK] position:

The switch is locked on, so that the effect continues to be applied even if you remove your hand from the lever. To stop the effect, return the lever to the middle position [OFF].

When pulled toward you to the [ON] position:

The effect is applied only while the lever is pulled to the [ON] position; when the lever is released, it returns automatically to the middle [OFF] position. Use this function when you wish to alternate rapidly between ON and OFF.

DEPTH dial

Set to the center center indent position for standard effect sounds. For more information regarding the change in parameter 1 in response to DEPTH dial rotation, see pages 10, 11, 13.

CHARACTER dial

Set to the center center indent position for standard effect sounds. For more information regarding the change in parameter 2 in response to CHARACTER dial rotation, see pages 10, 11, 13.

MIX dial

Use to adjust the mixing balance of original and effect sounds. Set to the center indent position for standard effect sounds.

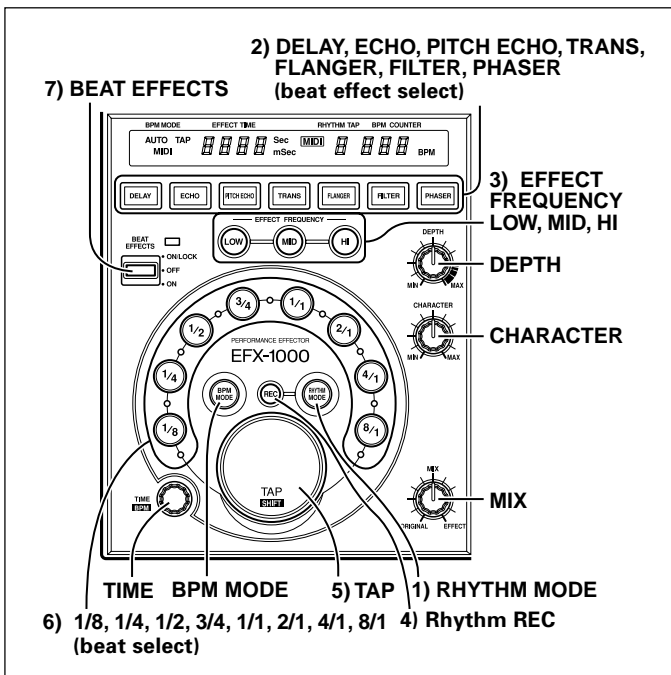

Beat Effects [RHYTHM mode]

The beat effects [RHYTHM mode] function allows you to create a variety of effects synchronized with your own input rhythm.

- Use the **RHYTHM MODE** button to set to rhythm mode.
 - The **RHYTHM MODE** button lights.
- Use the beat effect select buttons to select the desired effect.
 - Select from **DELAY**, **ECHO**, **PITCH ECHO**, **TRANS**, **FLANGER**, **FILTER**, or **PHASER**.
 - The selected effect button flashes.
 - See pages 10, 11 regarding each effect.
- Use the **EFFECT FREQUENCY** buttons (**LOW**, **MID**, **HI**) to select the band to which the effect is to be applied.
 - When a button is pressed, the button's indicator will light.
 - Each time a button is pressed, it alternates ON/OFF.
- Press rhythm **REC** button to set to **REC** mode.
 - The BPM display will indicate "REC".
 - If no rhythm has been input, the unit will automatically enter the REC mode in step 1.
- Input the desired rhythm using the **TAP** button.
 - Input taps will be recognized as a tempo when occurring at intervals of less than 2 seconds. Up to 8 taps can be input.
 - The counted taps (**RHYTHM TAP**) will be shown in the display.
 - During rhythm input, the beat select button [1/1] will be selected.

- Select one of the beat select buttons to establish the overall time for the input rhythm.

- The overall time for the input rhythm will be multiplied in response to the selected button.
- Select from 1/8, 1/4, 1/2, 3/4, 1/1, 2/1, 4/1, or 8/1.
- The selected beat button lights.

- Pull the **BEAT EFFECTS** lever switch to **ON** to apply the effect.

When pushed away from you to the [ON/LOCK] position:

The switch is locked on, so that the effect continues to be applied even if you remove your hand from the lever. To stop the effect, return the lever to the middle position [OFF].

When pulled toward you to the [ON] position:

The effect is applied only while the lever is pulled to the [ON] position; when the lever is released, it returns automatically to the middle [OFF] position. Use this function when you wish to alternate rapidly between ON and OFF.

- If the Rhythm **REC** button is pressed during the rhythm mode, the input rhythm will be cleared and rhythm input mode is once again enabled.

DEPTH dial

Set to the center center indent position for standard effect sounds. For more information regarding the change in parameter 1 in response to **DEPTH** dial rotation, see pages 10, 11, 13.

CHARACTER dial

Set to the center center indent position for standard effect sounds. For more information regarding the change in parameter 2 in response to **CHARACTER** dial rotation, see pages 10, 11, 13.

MIX dial

Use to adjust the mixing balance of original and effect sounds. Set to the center indent position for standard effect sounds.

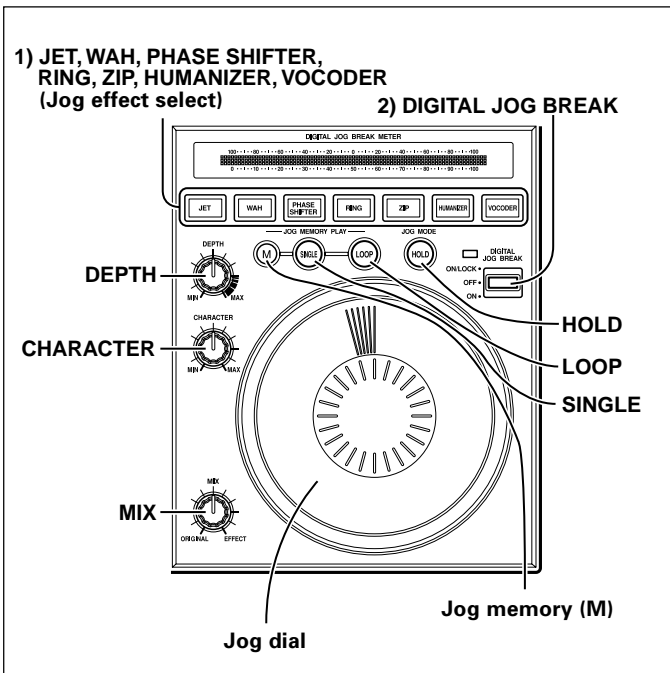

Digital Jog Break

Since the digital jog break can continuously change the parameters of each effect generated by rotating the Jog dial, the effects can be controlled like a musical instrument. Further, by using the jog memory function, the continuously changing effect sound can be stored in memory, and later played back by pressing one of the JOG MEMORY PLAY buttons (SINGLE or LOOP).

1. Use the Jog effect select buttons to select the desired effect.

- Select from **JET, WAH, PHASE SHIFTER, RING, ZIP, HUMANIZER, or VOCODER.**
- The selected Jog effect button flashes.
- See page 12 regarding each effect.

2. Set the DIGITAL JOG BREAK lever switch to ON and turn the Jog dial.

[DIGITAL JOG BREAK Lever switch operation]

When pushed away from you to the [ON/LOCK] position:

The switch is locked on, so that the effect continues to be applied even if you remove your hand from the lever. To stop the effect, return the lever to the middle position [OFF].

When pulled toward you to the [ON] position:

The effect is applied only while the lever is pulled to the [ON] position; when the lever is released, it returns automatically to the middle [OFF] position. Use this function when you wish to alternate rapidly between ON and OFF.

- Parameter changes caused by rotating the Jog dial are indicated on the DIGITAL JOG BREAK METER.

DEPTH dial

Set to the center center indent position for standard effect sounds. For more information regarding the change in parameter 1 in response to DEPTH dial rotation, see pages 12, 13.

CHARACTER dial

Set to the center center indent position for standard effect sounds. For more information regarding the change in parameter 2 in response to CHARACTER dial rotation, see pages 12, 13.

MIX dial

Use to adjust the mixing balance of original and effect sounds. Set to the center indent position for standard effect sounds.

HOLD Function

When the HOLD button is pressed and lit, the effect generated by the rotation of the Jog dial continues when the dial rotation stops.

Jog Memory

Up to 8 seconds of the digital jog break's jog dial movement can be stored in memory, and the effect later played back at a single touch.

1. Use the Jog effect select buttons to select the desired effect.

- Select from **JET, WAH, PHASE SHIFTER, RING, ZIP, HUMANIZER, or VOCODER.**
- The selected Jog effect button flashes.
- See page 12 regarding each effect.

2. Set the DIGITAL JOG BREAK lever switch to ON to monitor the effect.

3. Turn the Jog dial while holding down the Jog memory button (M).

Turning the Jog dial while the M button is held down starts memory storage. Effects are stored continues for 8 seconds or until the M button is released. The SINGLE or LOOP button lights.

- When an effect has already been stored in memory (SINGLE button and LOOP button are lighted), if a new effect is stored in memory, the previously stored contents will be overwritten and the effect data will be erased.

4. Press the SINGLE or LOOP button.

- When the SINGLE button is pressed, the button flashes and the stored effect produced by the jog dial movement is played back one time.
- When the LOOP button is pressed, the button flashes and the stored effect produced by the jog dial movement is played back repeatedly. Press the LOOP button once again to stop the effect playback.
- Jog dial operation stored in memory can be reproduced even when the type of effect is subsequently changed.

MIDI SETTINGS

MIDI (Musical Instrument Digital Interface) is a standard protocol designed to allow exchange of information between electronic instruments and/or computers. A MIDI cable is used to connect two appliances equipped with MIDI connectors, thus allowing data to be exchanged between the two appliances. The EFX-1000 uses MIDI to send and receive operation and BPM data (timing clock).

Synchronizing an external sequencer to an audio signal, or using EFX-1000 operation data to operate an external sequencer

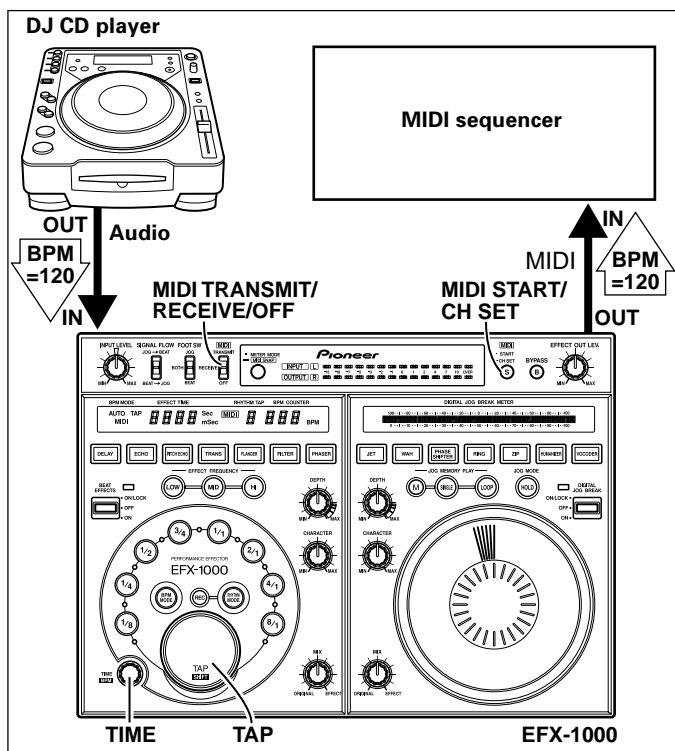

To synchronize beat effects to external sequencer, or use an external sequencer to operate the EFX-1000

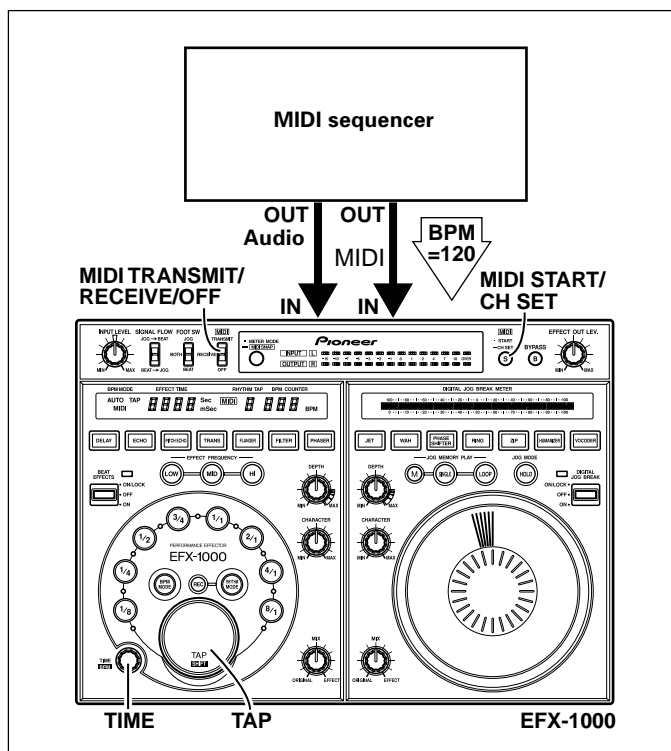

1. Use a commercially available MIDI cable to connect the EFX-1000's MIDI OUT connector and the MIDI sequencer's MIDI IN connector.

- The MIDI sequencer's sync mode should be set to slave.
- MIDI sequencers which do not support MIDI timing clock cannot be synchronized.

2. Set MIDI switch to [TRANSMIT] position.

- Sync cannot be performed in the case of tracks whose BPM values cannot be measured stably.
- Timing clock is also output for BPM values set by using the TAP mode.

3. Press the MIDI START/CH SET button.

- MIDI timing clock output range is 40-250 BPM.

[Setting TRANSMIT MIDI channel]

The TRANSMIT channel can be set and recorded in memory separately from the RECEIVE channel.

1. Set MIDI switch to [TRANSMIT] position.
2. In this condition, hold the MIDI START/CH SET button depressed.

- The MIDI indicator will flash and the setting mode will be enabled.

3. Rotate the TIME dial to select MIDI channel.

4. Press the MIDI START/CH SET button.

- The MIDI channel will be recorded, and the unit will leave the setting mode.

NOTE:

It may not be possible to set BPM correctly with some tracks.

1. Use a commercially available MIDI cable to connect the MIDI sequencer's MIDI OUT connector to the EFX-1000's MIDI IN connector.

- Adjust controls for optimum instrument input/output levels.
- Set all effect switches to OFF.
- Set BYPASS switch to OFF.

2. Set the MIDI switch to the [RECEIVE] position.

- The timing clock based on the BPM counted and displayed by this unit is output from the MIDI OUT connector.

3. Start the MIDI sequencer.

- Even during use of sequencer control, the EFX-1000 can be controlled directly if desired, but depending on the volume, the set parameter values may jump at the instant an operation is performed, so caution is needed.
- The range that the MIDI timing clock can accept is 40-250 BPM.

[Setting the RECEIVE MIDI channel]

The RECEIVE channel can be set and recorded in memory separately from the TRANSMIT channel.

1. Set MIDI switch to [RECEIVE] position.
2. In this condition, hold the MIDI START/CH SET button depressed.

- The MIDI indicator will flash and the setting mode will be enabled.

3. Rotate the TIME dial to select the MIDI channel, then press the TAP button to confirm.

NOTE:

If the MIDI sequencer's BPM is set in 0.1 units, it may not match the BPM display on the EFX-1000.

MIDI Implementation Chart

Function	Transmit	Receive	Comments	
Basic channel: When power ON Settable range	1-16 1-16	1-16 1-16	Stored in memory	
Mode: When power ON Message Replacement	Mode 3 X	Mode 3 X		
Note number: Sound range	X X	X X		
Velocity: Note ON Note OFF	X X	X X		
After touch: By Key By Channel	X X	X X		
Pitch Bender:	X	X		
Control change:	12, 44	○	○	Beat select time parameter (MSB, LSB)
	13, 45	○	○	Time parameter (MSB, LSB)
	16, 48	○	○	JOG parameter (MSB, LSB)
	17, 49	○	○	Rhythm parameter 1 (MSB, LSB)
	64	○	○	Effect ON/OFF
	66	○	○	Frequency select
	67	○	○	Rhythm parameter 2
	69	○	○	Beat Operation Mode
	80	○	○	VR parameter 1
	81	○	○	VR parameter 2
	82	○	○	VR parameter 3
83	○	○	VR parameter 4	
91	○	○	VR parameter 5	
92	○	○	VR parameter 6	
Program change: setting range	○	○		
Exclusive:	X	X		
Common: Song position Song select Tune	X X X	X X X		
Real time: Clock Command	○ ○	○ X	Transmit: start/stop	
Other: Local ON/OFF All Note/OFF Active sensing Reset	X X X X	X X X X		
Comments:				

Mode 1: Omni, ON, Poly
Mode 3: Omni, OFF, Poly

Mode 2: Omni, ON, Mono
Mode 4: Omni, OFF, Mono

○: Yes
X: No

Control Change (CC) Table

Function	EFX-1000 Operation	Message (Command)	Format (Hex)	Comments								
Effect type switching	Signal flow change	ProgramChange	Cn pc	See program change below.								
	Beat effect select											
	Digital jog break Effect select											
Effect ON/OFF	Beat effect (ON/OFF)	Hold 1	Bn 40 0b	Sets effect ON/OFF. b: Effect ON/OFF (ON = 1) Bit0 JOG Bit1 BEAT MSB <table border="1" style="display: inline-table; vertical-align: middle;"><tr><td>0</td><td>0</td><td>0</td><td>0</td><td>0</td><td>0</td><td>0</td><td>0</td></tr></table> BEAT JOG LSB	0	0	0	0	0	0	0	0
	0				0	0	0	0	0	0	0	
Digital jog break Effect (ON/OFF)												

Function	EFX-1000 Operation	Message (Command)	Format (Hex)	Comments																	
Effect time operation	Beat select	Effect Control 1	Bn 0c MSB Bn 2c LSB	Sets effect time. Setting range (unit: mSec) DELAY, ECHO, PITCH ECHO: 1-16000 TRANS: 10-16000 FLANGER, FILTER, PHASER: 5-16000 When 5-16000 are transmitted for FLANGER, FILTER, or PHASER, EFX-1000 internally multiplies value by x2, so as to operate at 10-32000. * On receive side, search is performed for beginning of effect cycle.																	
	TIME dial	Effect Control 2	Bn 0d MSB Bn 2d LSB	Sets effect time. Setting range (unit: mSec) DELAY, ECHO, PITCH ECHO: 1-16000 TRANS: 10-16000 FLANGER, FILTER, PHASER: 5-16000 When 5-16000 are transmitted for FLANGER, FILTER, or PHASER, EFX-1000 internally multiplies value by x2, so as to operate at 10-32000. * On receive side, search is not performed for beginning of effect cycle.																	
Beat operation	Effect frequency select	sostenuto	Bn 42 0b	Sets frequency range subjected to effect b: frequency range (ON = 1) Bit0 LOW Bit1 MID Bit2 HI <table border="1" style="margin-left: auto; margin-right: auto;"> <tr> <td colspan="5" style="text-align: center;">MSB</td> <td></td> <td colspan="3" style="text-align: center;">LSB</td> </tr> <tr> <td style="text-align: center;">0</td> <td style="text-align: center;">0</td> <td style="text-align: center;">0</td> <td style="text-align: center;">0</td> <td style="text-align: center;">0</td> <td style="text-align: center;">HI</td> <td style="text-align: center;">MID</td> <td style="text-align: center;">LOW</td> </tr> </table>	MSB						LSB			0	0	0	0	0	HI	MID	LOW
	MSB						LSB														
	0	0	0	0	0	HI	MID	LOW													
	Rhythm TAP (rhythm time)	General Purpose Controller 2	Bn 11 MSB Bn 31 LSB	Sets tap time interval for rhythm effect. Setting range (unit: mSec) 1-2000																	
Rhythm TAP (rhythm no.)	soft pedal	Bn 43 dd	Sets tap number for rhythm effect. Setting range: 1-8																		
BPM mode SW Rhythm mode SW Rhythm REC	hold 2	Bn 45 dd	Changes Beat operating mode. 1=BPM mode 2=Rhythm mode During rhythm mode, if rhythm mode is set again, the recorded rhythm effect will be canceled and new rhythm data can be input.																		
Jog operation	Jog dial	General Purpose Controller 1	Bn 10 MSB Bn 30 LSB	Sets jog dial movement. Setting range: 0-2160 Jog center position is considered 1080; when dial is rotated clockwise, changes to maximum 2160; when dial is rotated counterclockwise, changes to minimum 0.																	
Beat volume	Beat effect DEPTH	Effect 1 Depth	Bn 5B dd	Sets beat DEPTH value. Setting range: 0-127																	
	Beat effect CHARACTER	General Purpose Controller 5	Bn 50 dd	Sets beat CHARACTER value. Setting range: 0-127																	
	Beat effect MIX	General Purpose Controller 6	Bn 51 dd	Sets beat MIX value. Setting range: 0-127																	
Jog volume	Digital jog break DEPTH	Effect 2 Depth	Bn 5C dd	Sets Jog DEPTH value. Setting range: 0-127																	
	Digital jog break CHARACTER	General Purpose Controller 7	Bn 52 dd	Sets jog CHARACTER value. Setting range: 0-127																	
	Digital jog break MIX	General Purpose Controller 8	Bn 53 dd	Sets jog MIX value. Setting range: 0-127																	

Program Change

MSB				LSB			
0	SIGNAL FLOW	BEAT2	BEAT1	BEAT0	JOG2	JOG1	JOG0

● **BEAT EFFECTS**

BEAT2	BEAT1	BEAT0	
0	0	1	DELAY
0	1	0	ECHO
0	1	1	PITCH ECHO
1	0	0	TRANS
1	0	1	FLANGER
1	1	0	FILTER
1	1	1	PHASER

Use general purpose 8 for setting filters

● **SIGNAL FLOW**

- 0 = BEAT EFFECTS → JOG BREAK
- 1 = JOG BREAK → BEAT EFFECTS

● **JOG BREAK**

JOG2	JOG1	JOG0	
0	0	1	JET
0	1	0	WAH
0	1	1	PHASE SHIFTER
1	0	0	RING
1	0	1	ZIP
1	1	0	HUMANIZER
1	1	1	VOCODER

About Rhythm Effects

(Example shown is 3 rhythms)

During TRANSMIT:

Each time rhythm TAP is struck, data is transmitted in the order rhythm parameter 2 (rhythm No.) and rhythm parameter 1 (rhythm time).

Effector operation

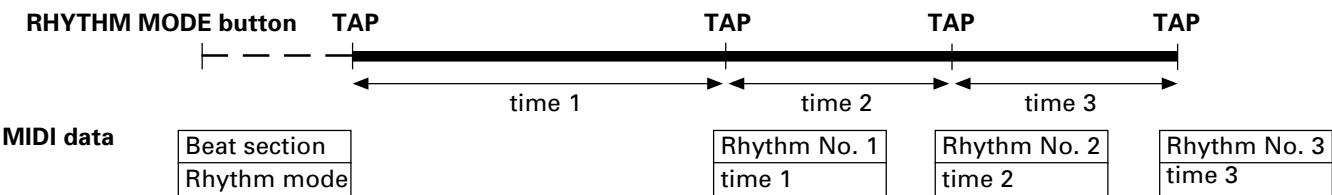

During RECEIVE:

- During beat effect, if beat operation mode (rhythm mode) is received, the rhythm effect function is enabled. Thereafter, if the first time rhythm No. 1, time 1, rhythm No. 2, time 2, rhythm No. 3, time 3 are transmitted in that order, the effector continues to operate in response to the received rhythm.
- During rhythm effect, if the beat operation mode (BPM mode) is transmitted, the function returns to beat effect.

Snapshot

Once the effector is set to a target value, a snapshot of that state can be taken. When snapshot is used, all commands for control change are transmitted at once.

When setting [TRANSMIT], hold the **METER MODE/MIDI SNAP** button depressed to transmit the snapshot. When this is done the **MIDI** indicator will flash.

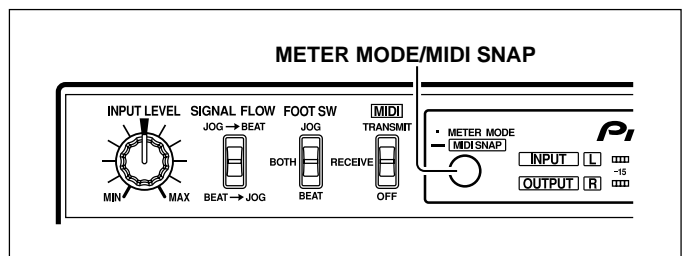

TROUBLESHOOTING

Incorrect operations are often mistaken for trouble and malfunctions. If you think there is something wrong with this component, check the points below. Sometimes the trouble may originate from another component. Thus, also check the other electrical appliances also in use.

If the trouble cannot be rectified even after checking the following items, contact your dealer or nearest PIONEER service center.

Symptom	Probably cause	Remedy												
No power	<ul style="list-style-type: none"> Power cord isn't connected. 	<ul style="list-style-type: none"> Connect power cord to outlet. 												
No sound, or too low	<ul style="list-style-type: none"> Connection cords are loose or aren't connected properly. Connector terminals and plugs are dirty. Input level is set too low. Effect output level is set too low. 	<ul style="list-style-type: none"> Connect properly. Wipe away dirt and soil. Rotate INPUT LEVEL dial toward right ([MAX] direction). Try setting IN&OUT LEVEL switch to the opposite position. Rotate EFFECT OUT LEV. dial toward right ([MAX] direction). 												
Analog inputs aren't output	<ul style="list-style-type: none"> A digital or EFX LINK input is connected. When analog and digital inputs are connected simultaneously, the digital input is given priority. The DJ mixer (DJM-1000) connected by EFX LINK has its effector link set to ON (EFX LINK). 	<ul style="list-style-type: none"> Cancel the EFX LINK, and disconnect any digital input with priority over analog inputs. The order of priority of inputs is: EFX LINK > Digital input > Analog input. 												
Digital signals aren't output.	<ul style="list-style-type: none"> EFX LINK is connected to DJ mixer (DJM-1000) via digital link cable. The digital output fs setting does not match the connected component. 	<ul style="list-style-type: none"> If EFX LINK is connected to DJ mixer (DJM-1000) via digital link cable, ordinary digital signals are not output. Disconnect the digital link cable. Set the digital output fs to match the connected component. 												
When set to BYPASS, analog signals aren't output.	<ul style="list-style-type: none"> No analog inputs are connected. Even if a digital input or EFX LINK is connected, analog inputs are output as analog during BYPASS mode. 	<ul style="list-style-type: none"> Use analog signals for input. Or use digital output. Outputs when BYPASS is selected are as follows: <table border="1"> <thead> <tr> <th>Input connection conditions</th> <th>Analog output</th> <th>Digital output</th> </tr> </thead> <tbody> <tr> <td>Analog only</td> <td>Analog source</td> <td>Analog source</td> </tr> <tr> <td>Digital only</td> <td>(no output)</td> <td>Digital source</td> </tr> <tr> <td>Analog & digital</td> <td>Analog source</td> <td>Digital source</td> </tr> </tbody> </table>	Input connection conditions	Analog output	Digital output	Analog only	Analog source	Analog source	Digital only	(no output)	Digital source	Analog & digital	Analog source	Digital source
Input connection conditions	Analog output	Digital output												
Analog only	Analog source	Analog source												
Digital only	(no output)	Digital source												
Analog & digital	Analog source	Digital source												
Effect sounds aren't applied.	<ul style="list-style-type: none"> The lever switch is set to [OFF]. MIX dial is set to [MIN]. DEPTH dial is set to [MIN]. EFFECT OUT LEV. dial is set to [MIN]. BYPASS button is ON. EFFECT FREQUENCY indicators (HI, MID, LOW) are all off (during use of TRANS, FLANGER, FILTER, or PHASER effects). Some combinations of effects may have weak results. Particularly, some combinations of beat effects and digital jog break may sound weak. 	<ul style="list-style-type: none"> Either hold lever switch in [ON] position, or set to [ON/LOCK]. Rotate MIX dial toward the right ([MAX] direction). Rotate DEPTH dial toward the right ([MAX] direction). Rotate EFFECT OUT LEV. dial toward the right ([MAX] direction). If BYPASS indicator is flashed, no effects will be output. Press BYPASS so that the indicator goes out. If EFFECT FREQUENCY indicators are all off, only the original sound will be output. Press the button corresponding to the frequency band to which you wish to apply effects (the button's indicator will light). Try setting SIGNAL FLOW switch to the opposite position (reverse order of signal processing for beat effects and digital jog break). 												
No effect sound is heard when beat effects are applied.	<ul style="list-style-type: none"> EFFECT FREQUENCY indicators (HI, MID, LOW) are all off (during use of DELAY, ECHO, PITCH ECHO effects). 	<ul style="list-style-type: none"> If EFFECT FREQUENCY indicators are all off, no effect sound will be output. Press the button corresponding to the frequency band to which you wish to apply effects (the button's indicator will light). 												

OTHER (TROUBLESHOOTING)

Symptom	Probably cause	Remedy
When a foot switch is connected, effects are applied even without pressing the foot switch.	<ul style="list-style-type: none"> ● Foot switch's logic is reversed (the effector applies effects when the foot switch is depressed for LOW level). 	<ul style="list-style-type: none"> ● Use a foot switch with logic matching that of the effector.
Effect sounds are distorted.	<ul style="list-style-type: none"> ● Input level is too high. ● Effect output level is too high. ● Effect settings are too high (When the DEPTH dial is set near its [MAX] position, it may have the effect of raising the volume level.) 	<ul style="list-style-type: none"> ● Rotate INPUT LEVEL dial toward left ([MIN] direction). ● Try setting IN&OUT LEVEL switch to the opposite position. ● Rotate EFFECT OUT LEV. dial toward left ([MIN] direction). ● Rotate DEPTH dial toward left ([MIN] direction).
Can't use EFX LINK function	<ul style="list-style-type: none"> ● The digital link cable is not connected. ● The connected component is not supported. ● The DJ mixer's settings are incorrect 	<ul style="list-style-type: none"> ● Connect the digital link cable to a DJ mixer (with digital link support) ● Set the DJ mixer for EFX LINK.
Can't use the BPM sync function.	<ul style="list-style-type: none"> ● DJ mixer is not connected for EFX LINK. ● A DJ CD player with digital link support is not connected to the DJ mixer. ● The BPM measurement mode is not set to [AUTO]. 	<ul style="list-style-type: none"> ● Connect the DJ CD player and DJ mixer via digital link. ● Set the DJ effector's BPM mode to [AUTO].
Echo sounds are output continuously	<ul style="list-style-type: none"> ● During echo effect, if DEPTH dial is set to [MAX] and BEAT EFFECTS lever switch is moved from [ON] to [OFF], the feedback sound dies not attenuate, producing a hold delay effect. 	<ul style="list-style-type: none"> ● Rotate DEPTH dial toward the left ([MIN] direction).
BPM doesn't count tempo in AUTO mode. BPM count is strange.	<ul style="list-style-type: none"> ● Input level is too high, or too low. ● Some tracks have tempos that prevent them from being measured automatically. (Automatic measurement range is 70-180 BPM). 	<ul style="list-style-type: none"> ● Rotate INPUT LEVEL dial so that the input level meter shows around 0 dB. ● Set to manual mode and input (TAP) the tempo manually (P.18)
MIDI sequencer isn't synchronized.	<ul style="list-style-type: none"> ● The MIDI sequencer's sync mode is not set to "slave". ● The connected MIDI sequencer is not supported. 	<ul style="list-style-type: none"> ● Set MIDI sequencer's sync mode to "slave." ● A MIDI sequencer without MIDI timing clock cannot be synchronized.

- This component may fail to operate properly due effects from static electricity or other causes. In this event, try disconnecting the power cord and reconnecting it. If this doesn't solve the problem, consult your dealer or nearest Pioneer Service Station.

SPECIFICATIONS

1. General

Power supply	AC 120 V, 60 Hz
Power consumption	16 W
Operating temperature	+5°C to +35°C (+41°F to +95°F)
Relative humidity	5% to 85% (without condensation)
Weight	2.4 kg (5.3 lb)
Maximum external dimensions	320 (W) x 234 (D) x 101 (H) mm
	12-19/32 (W) x 9-7/32 (D) x 3-31/32 (H) in.

2. Audio Unit

Sampling rate	96 kHz
A/D, D/A Resolution	24 bits
Frequency characteristics	20 Hz to 22 kHz
S/N ratio	83 dB
Distortion	0.02 %
Headroom	19 dB
Input level	-10 dBV / +4 dBu (22 kΩ)
Output level	-10 dBV / +4 dBu
	(RCA pin jacks: 1 kΩ, Phone jacks: 1 kΩ)
	*-10 dBV / +4 dBu is switchable.

3. Input/Output terminals

Audio line input terminal	
RCA pin jacks	2
Phone jacks (1/4-inch/6.3 mm in diameter)	2
Audio line output terminal	
RCA pin jacks	2
Phone jacks (1/4-inch/6.3 mm in diameter)	2
Digital input terminal	
RCA pin jack	1
Digital output terminal	
RCA pin jack	1
EFX LINK connector (mini-DIN)	1
MIDI input terminal (5-pin DIN)	1
MIDI output terminal (5-pin DIN)	1

4. Accessories

Operating instructions	1
Digital link cable	1
Power cord	1
Warranty	1

NOTE:

Specifications and design are subject to possible modification without notice.

BLOCK DIAGRAM

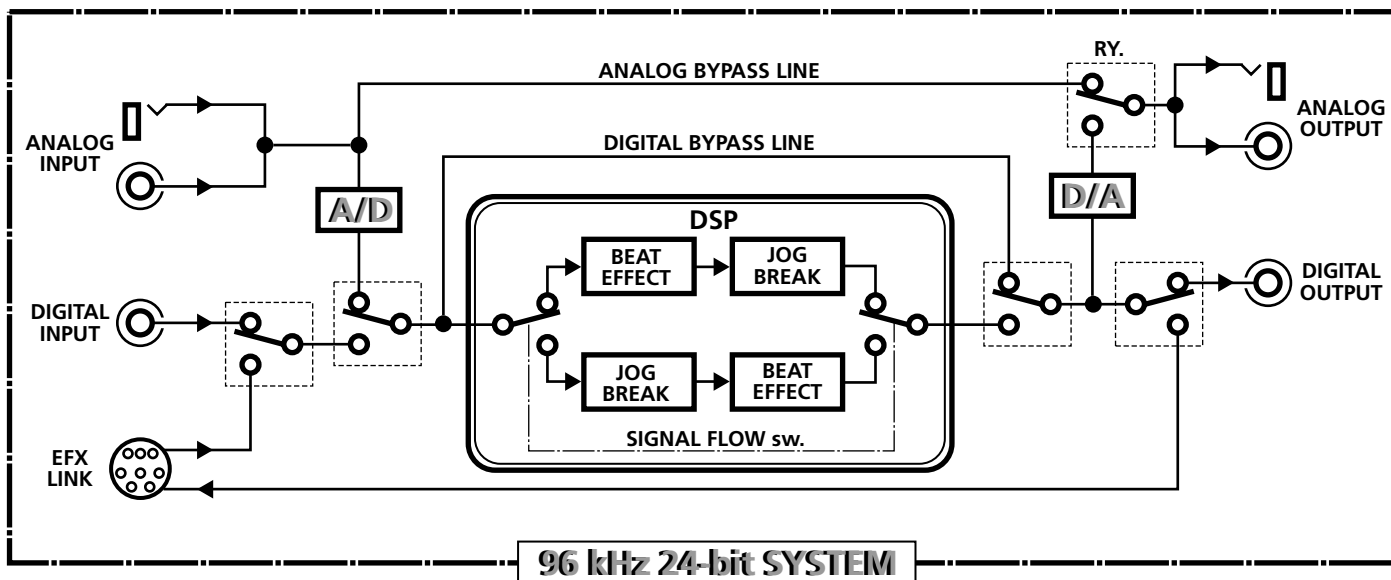



Dear Customer:

Selecting fine audio equipment such as the unit you've just purchased is only the start of your musical enjoyment. Now it's time to consider how you can maximize the fun and excitement your equipment offers. This manufacturer and the Electronic Industries Association's Consumer Electronics Group want you to get the most out of your equipment by playing it at a safe level. One that lets the sound come through loud and clear without annoying blaring or distortion-and, most importantly, without affecting your sensitive hearing.

Sound can be deceiving. Over time your hearing "comfort level" adapts to higher volumes of sound. So what sounds "normal" can actually be loud and harmful to your hearing. Guard against this by setting your equipment at a safe level BEFORE your hearing adapts.

To establish a safe level:

- Start your volume control at a low setting.
- Slowly increase the sound until you can hear it comfortably and clearly, and without distortion.

Once you have established a comfortable sound level:

- Set the dial and leave it there.

Taking a minute to do this now will help to prevent hearing damage or loss in the future. After all, we want you listening for a lifetime.

We Want You Listening For A Lifetime

Used wisely, your new sound equipment will provide a lifetime of fun and enjoyment. Since hearing damage from loud noise is often undetectable until it is too late, this manufacturer and the Electronic Industries Association's Consumer Electronics Group recommend you avoid prolonged exposure to excessive noise. This list of sound levels is included for your protection.

Decibel Level Example

30	Quiet library, soft whispers
40	Living room, refrigerator, bedroom away from traffic
50	Light traffic, normal conversation, quiet office
60	Air conditioner at 20 feet, sewing machine
70	Vacuum cleaner, hair dryer, noisy restaurant
80	Average city traffic, garbage disposals, alarm clock at two feet.

THE FOLLOWING NOISES CAN BE DANGEROUS UNDER CONSTANT EXPOSURE

90	Subway, motorcycle, truck traffic, lawn mower
100	Garbage truck, chain saw, pneumatic drill
120	Rock band concert in front of speakers, thunderclap
140	Gunshot blast, jet plane
180	Rocket launching pad

Information courtesy of the Deafness Research Foundation.



5001_En

Should this product require service in the U.S.A. and you wish to locate the nearest Pioneer Authorized Independent Service Company, or if you wish to purchase replacement parts, operating instructions, service manuals, or accessories, please call the number shown below.

(800) 421-1404

Please do not ship your product to Pioneer without first calling the Customer Support Division at the above listed number for assistance.

**PIONEER ELECTRONICS (USA), INC.
CUSTOMER SUPPORT DIVISION
P.O. BOX 1760, LONG BEACH,
CA 90801-1760, U.S.A.**

For warranty information please see the Limited Warranty sheet included with your product.

Should this product require service in Canada, please contact a Pioneer Canadian Authorized Dealer to locate the nearest Pioneer Authorized Service Company in Canada. Alternatively, please contact the Customer Service Department at the following address:

Pioneer Electronics of Canada, Inc.

**300 Allstate Parkway
Markham, ON L3R OP2
(905) 479-4411
1 (877) 283-5901**

For warranty information please see the Limited Warranty sheet included with your product.

Published by Pioneer Corporation.
Copyright © 2004 Pioneer Corporation.
All rights reserved.

PIONEER CORPORATION 1-1, Shin-ogura, Saiwai-ku, Kawasaki-shi, Kanagawa 212-0031, Japan

PIONEER ELECTRONICS (USA) INC.

P.O. BOX 1540, Long Beach, California 90801-1540, U.S.A. TEL: (800) 421-1404

PIONEER ELECTRONICS OF CANADA, INC.

Industrial Products Department: 300 Allstate Parkway, Markham, Ontario L3R OP2, Canada TEL: 905-479-4411